



5+



20



2,4m



1 = 3,5m
2 = 2,46m
3 = 2,4m



Physical inclusion
Sensory inclusion
Cognitive inclusion

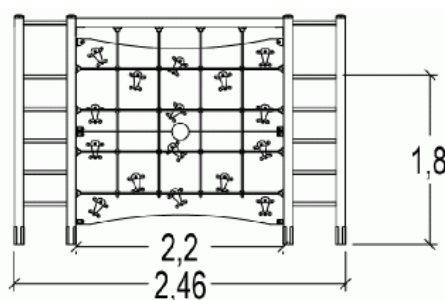
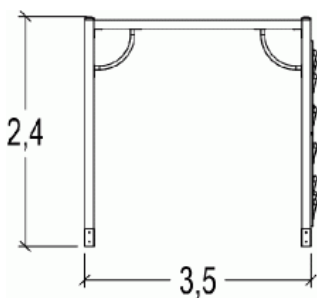
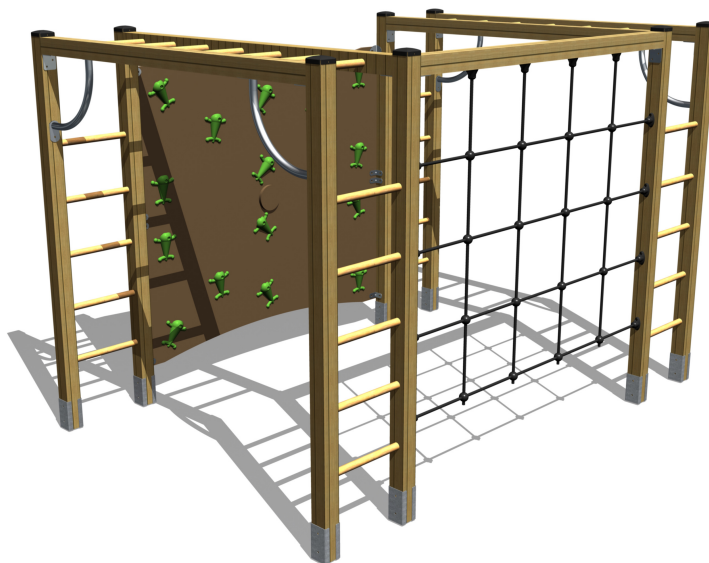

Play value :

8

climbing



x1

hanging



x2

climbing



x1

getting across



x4

Components

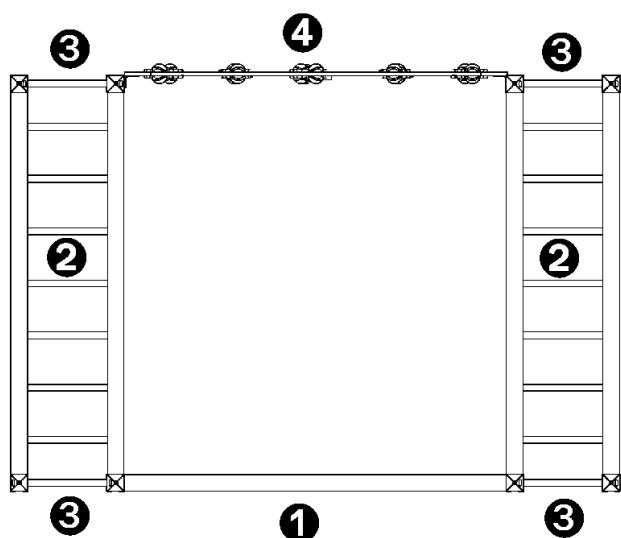

- ① Climbing net
- ② Suspension ladder
- ③ Step ladder
- ④ Climbing wall



Installation of equipment

IMPORTANT: It is essential to refer to the installation instructions for information on the size of the safety areas.

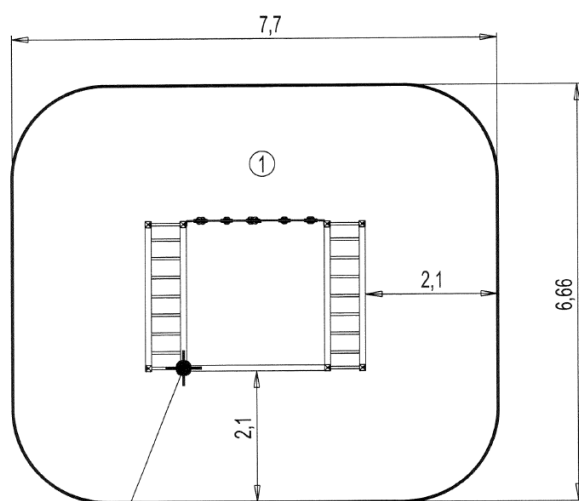
-  Impact area (minimum normative surface)
-  Free space



Point de Référence
Setting Out Point
Punto de referencia
Bezugspunkt

		
1	2,40m	49,5m ²



2



07h00



0.3m³



49.5m²



344kg



42kg

