

 **6+**
 **2**
 **1,3m**

 1 = 2,75m
 2 = 0,4m
 3 = 1,57m



Physical inclusion
Sensory inclusion
Cognitive inclusion

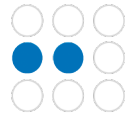
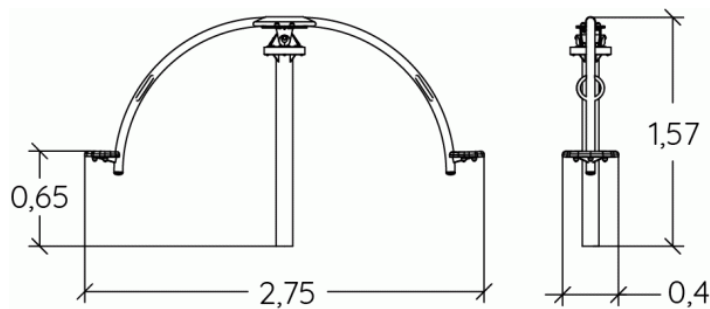

If installed onto wetpour safer surfacing, we recommend a NON-FINES CONCRETE BASE.



Play value : **4**

meeting



x1

swinging



x1

balancing



x1



rotating



x1



Installation of equipment

IMPORTANT: It is essential to refer to the installation instructions for information on the size of the safety areas.

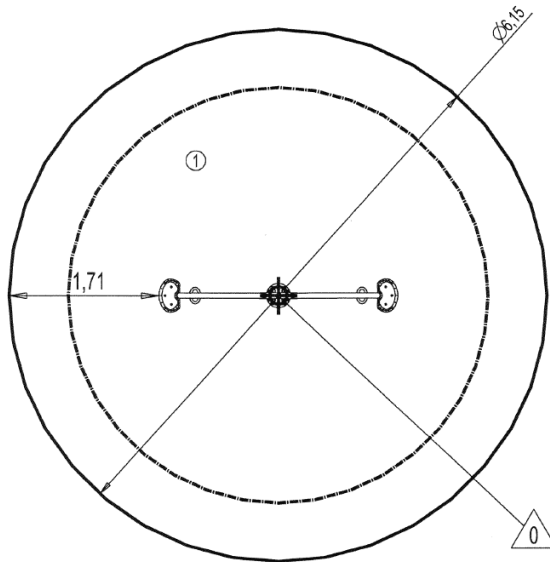
-  Impact area (minimum normative surface)
-  Free space



Point de Référence
Setting Out Point
Punto de referencia
Bezugspunkt
Referentiepunt

| | | |
|---|---|---|
| |  |  |
| 1 | 1,30m | 30m ² |



2



03h00



0.3m³



30m²



101kg



37kg

