



4+



23



2,6m



1 = 15m
2 = 3,8m
3 = 3,2m



Physical inclusion
Sensory inclusion
Cognitive inclusion

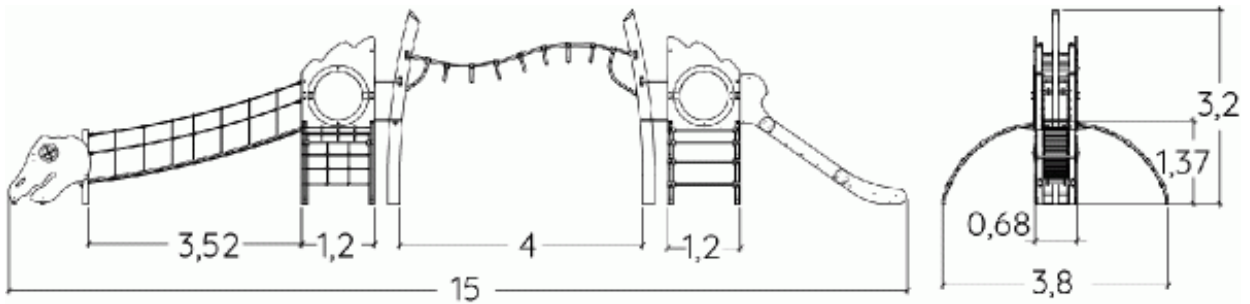
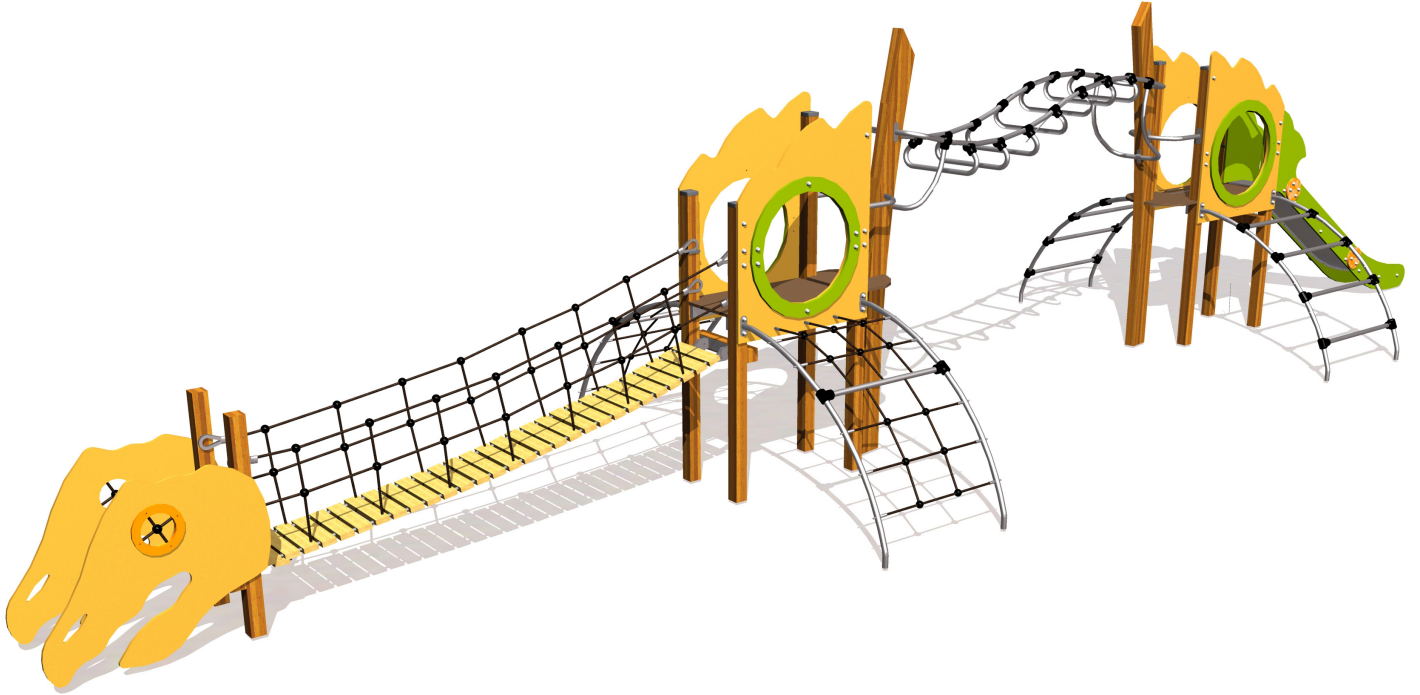
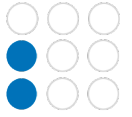

Play value :

6

role play



x1

sliding



x1

meeting



x1

hanging



x1

climbing



x1

getting across



x1

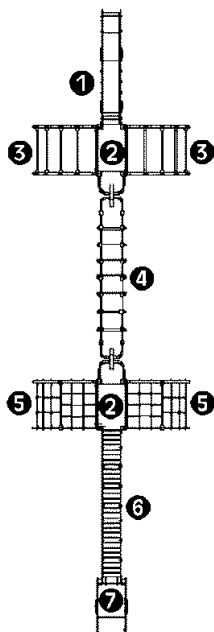

Components





- ❶ Slide HT: 1.37m
- ❷ Platforms HT: 1.37m
- ❸ Arched ladder
- ❹ Acrobranch
- ❺ Incline net HT: 1.37m
- ❻ Flexible bridge
- ❼ Crow's nest

Installation of equipment

IMPORTANT: It is essential to refer to the installation instructions for information on the size of the safety areas.

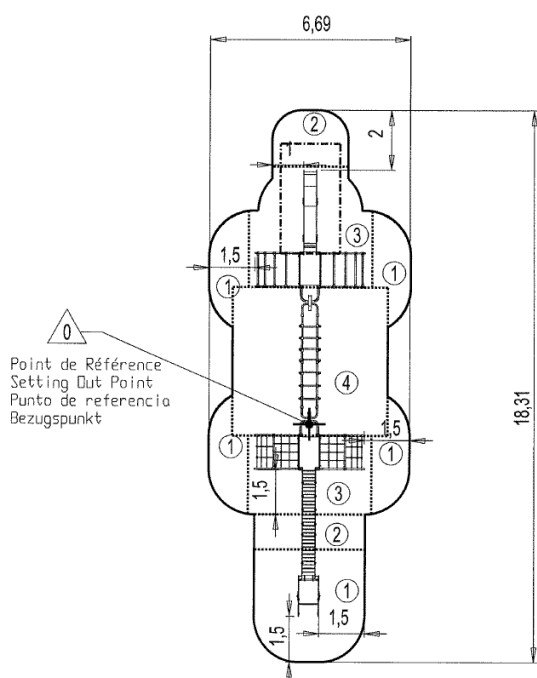
-  Impact area (minimum normative surface)
-  Free space



		
1	0,60m	27,5m ²
2	1,00m	9m ²
3	1,37m	26m ²
4	2,6m	26m ²



2

25h00

0.75m³

88.5m²

732kg

51kg

EN

1176