



4+



23



2,6m



1 = 15,42m
2 = 3,72m
3 = 3,2m



Physical inclusion
Sensory inclusion
Cognitive inclusion

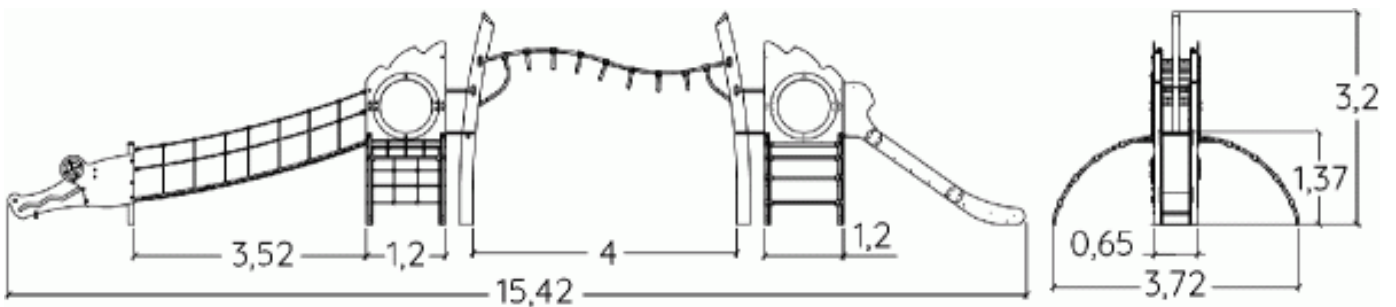
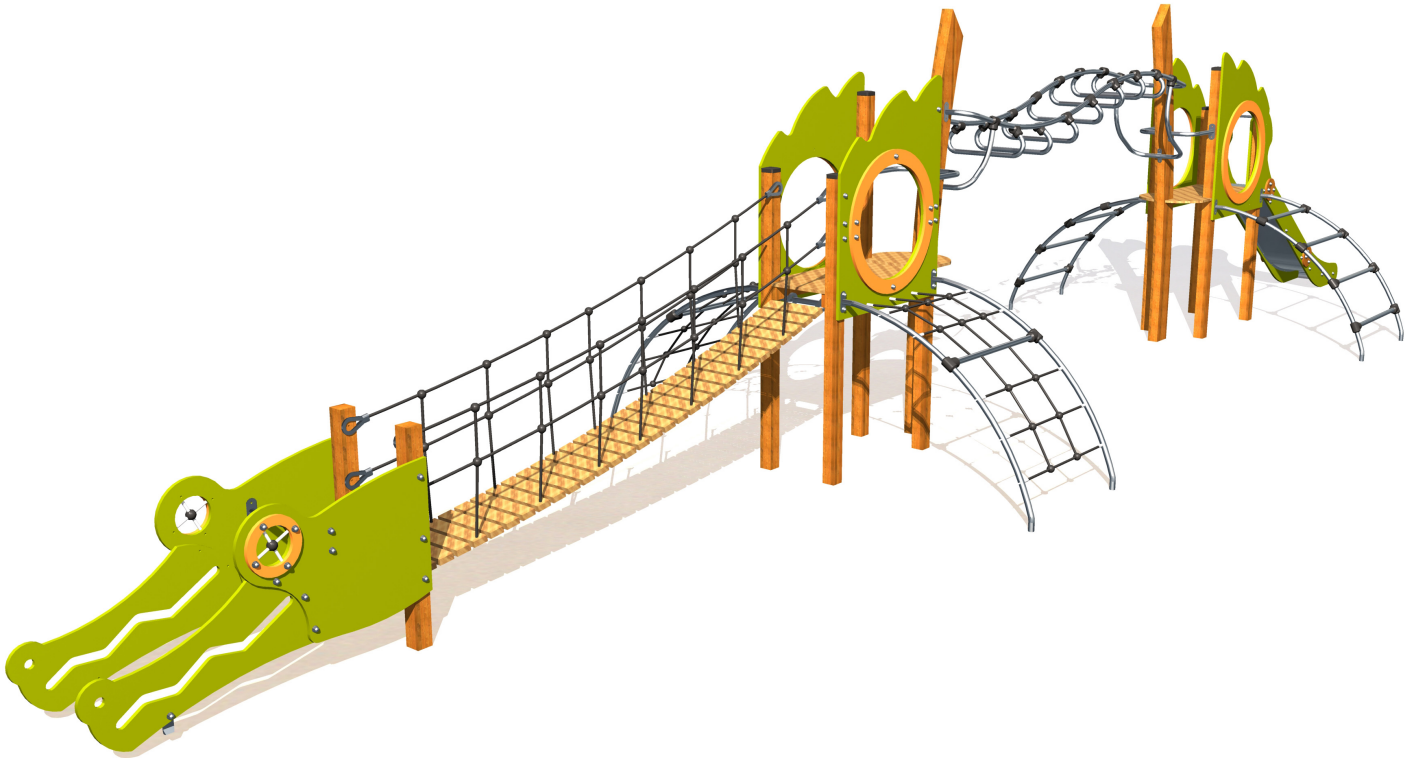
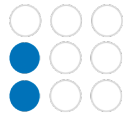

Play value :

6

role play



x1

sliding



x1

meeting



x1

hanging



x1

climbing



x1

getting across



x1

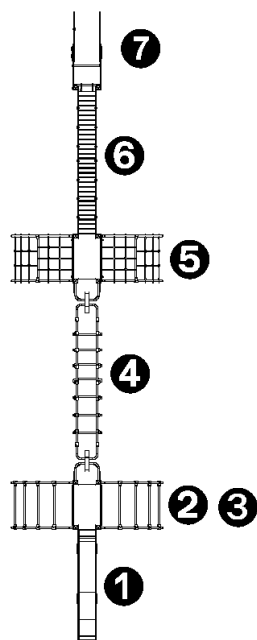

Components





- ① Slide HT: 1.37m
- ② Platforms HT: 1.37m
- ③ Arched ladder
- ④ Acrobranch
- ⑤ Incline net HT: 1.37m
- ⑥ Flexible bridge
- ⑦ Crow's nest

Installation of equipment

IMPORTANT: It is essential to refer to the installation instructions for information on the size of the safety areas.

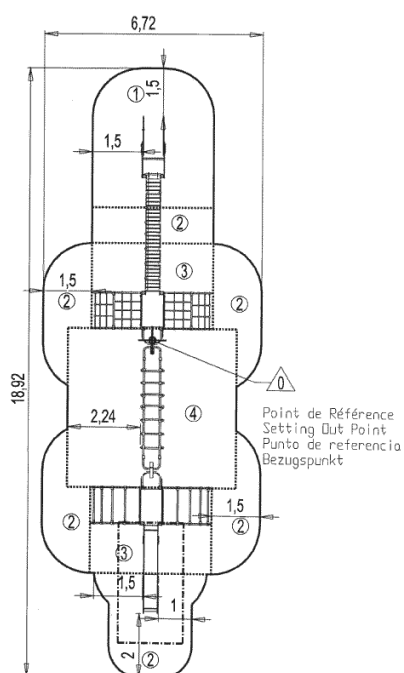
-  Impact area (minimum normative surface)
-  Free space



		
1	<0,6m	15,5m ²
2	1m	31m ²
3	1,37m	20m ²
4	2,6m	26m ²



2



25h00



0.8m³



92.5m²



735kg



51kg

