

Physical inclusion
Sensory inclusion
Cognitive inclusion

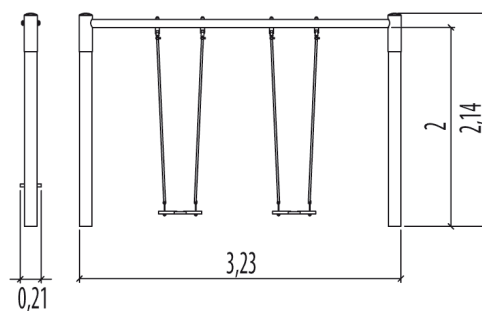

Play value : **2**

meeting



x1



swinging





x1

Installation of equipment

IMPORTANT: It is essential to refer to the installation instructions for information on the size of the safety areas.

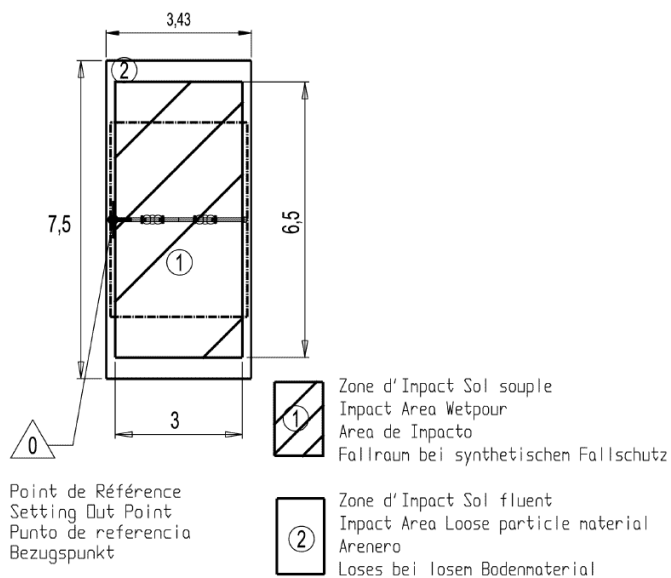
-  Impact area (minimum normative surface)
-  Free space



		
1	1,2m	19,5m ²
2	1,2m	26m ²



2



01h30



0.5m³



19.5m²



84kg



30kg

