

 **2+**
 **2**
 **0,6m**



1 = 1,08m
2 = 0,35m
3 = 0,92m



Physical inclusion
Sensory inclusion
Cognitive inclusion

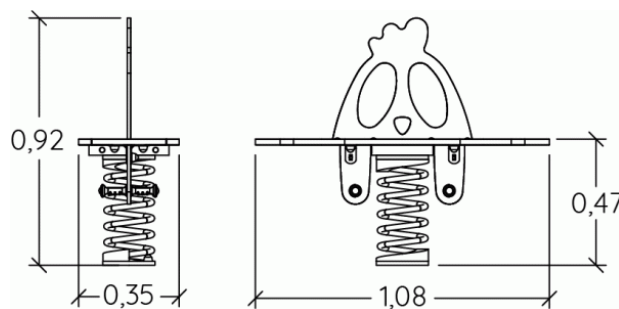
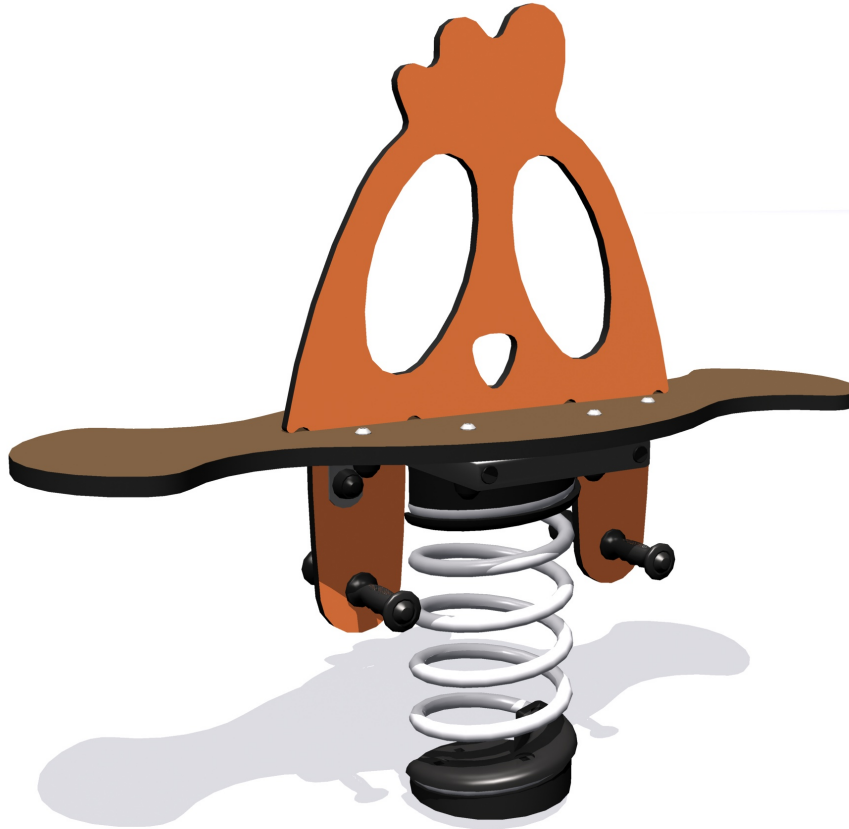

Play value :

3

role play

balancing

Oscillate



x1





x1





x1

Installation of equipment

IMPORTANT: It is essential to refer to the installation instructions for information on the size of the safety areas.

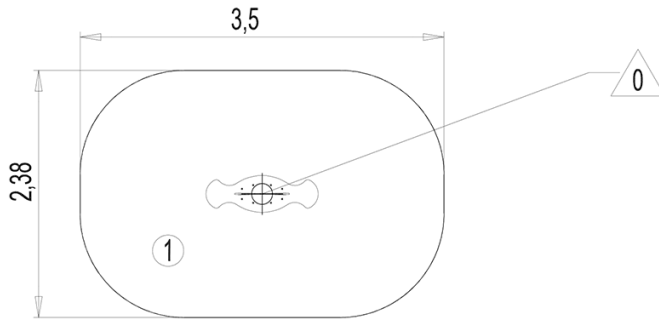
-  Impact area (minimum normative surface)
-  Free space



		
1	0,47m	7,5m ²



1

01h00

0m³

7.5m²

27kg

11kg

