

Physical inclusion
Sensory inclusion
Cognitive inclusion

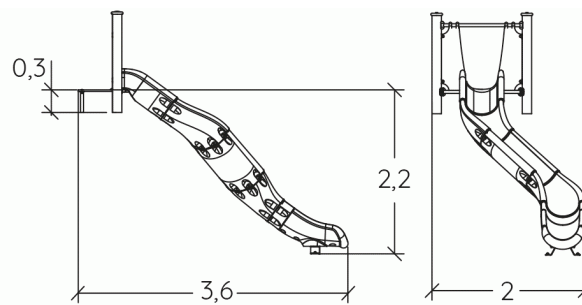

Play value : **2**

sliding



x1



meeting



x1

Installation of equipment

IMPORTANT: It is essential to refer to the installation instructions for information on the size of the safety areas.

-  Impact area (minimum normative surface)
-  Free space

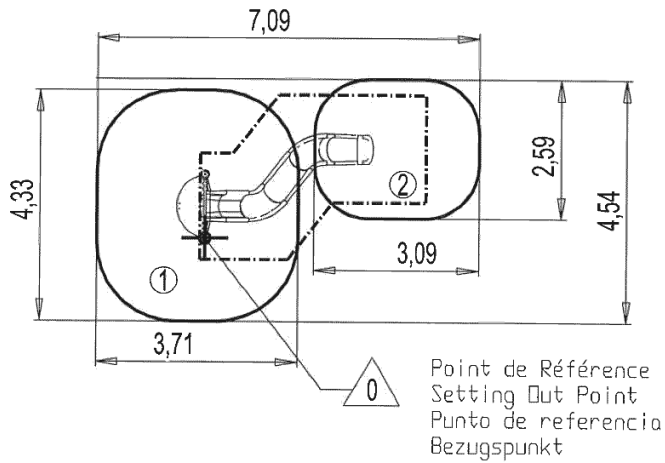

1	<0,6m	14,5m ²
2	1m	7,5m ²



2



05h00



0.2m³



22m²



150kg



20kg

