



 **8+**
 **42**
 **2,9m**



Physical inclusion  
Sensory inclusion  
Cognitive inclusion

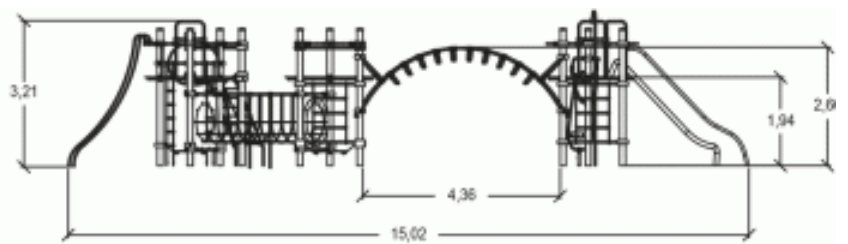
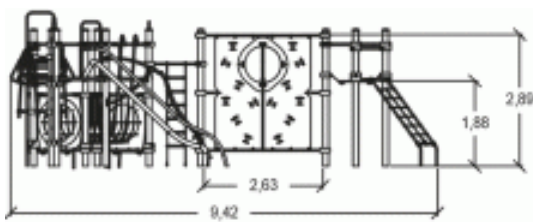
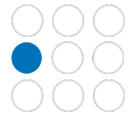

**Play value : 27**

climbing	sliding	meeting	resting	hanging	crawling	balancing	rotating
							
<b>x1</b>	<b>x4</b>	<b>x4</b>	<b>x2</b>	<b>x1</b>	<b>x1</b>	<b>x5</b>	<b>x1</b>
climbing	getting across						
							
<b>x5</b>	<b>x3</b>						

## Components

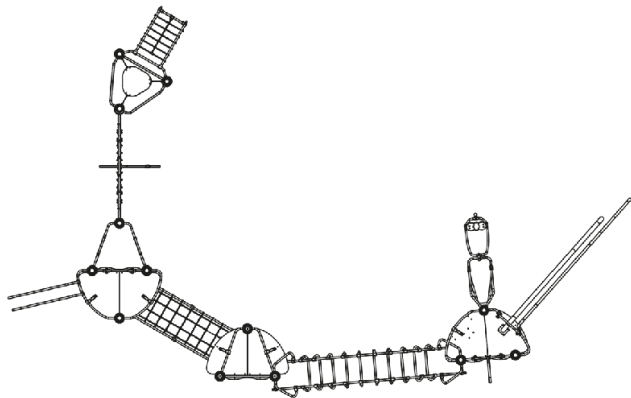

- ❶ Tour Epsilon
- ❷ Tour Gamma
- ❸ Tour Delta
- ❹ Tour Alpha
- ❺ Gyro
- ❻ Turbo Slide
- ❼ Echelle droite delta
- ❽ Fireman's pole
- ❾ Great arch
- ❿ Suspended platform
- ⓫ Filet tunnel
- ⓬ Speed slide
- ⓭ Portique à grimper
- ⓮ Climbing wall
- ⓯ Incline net

## Installation of equipment

**IMPORTANT:** It is essential to refer to the installation instructions for information on the size of the safety areas.

- Impact area (minimum normative surface)
- Free space

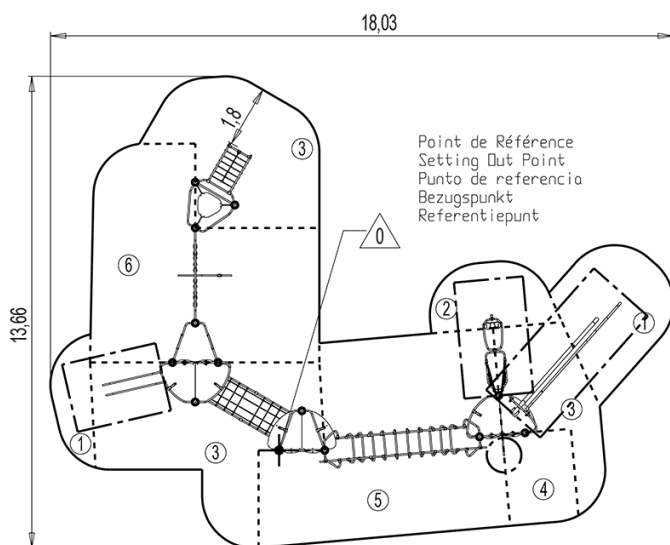

1	0,60m	14m <sup>2</sup>
2	0,70m	6m <sup>2</sup>
3	1,95m	48,5m <sup>2</sup>
4	2,2m	5,5m <sup>2</sup>
5	2,4m	35m <sup>2</sup>
6	2,9m	32,5m <sup>2</sup>



2



52h30



1.1m<sup>3</sup>



141.5m<sup>2</sup>



953kg



65kg

EN

1176