

 **2+**
 **10**
 **1m**



 1 = 3,26m
 2 = 1,72m
 3 = 2,6m



Physical inclusion
Sensory inclusion
Cognitive inclusion

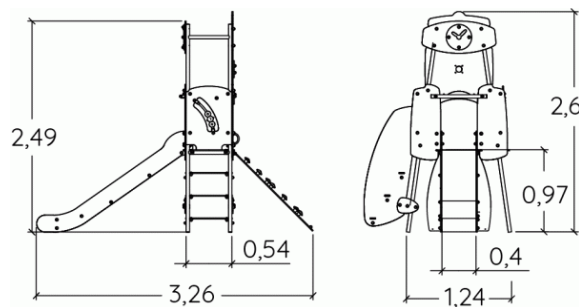
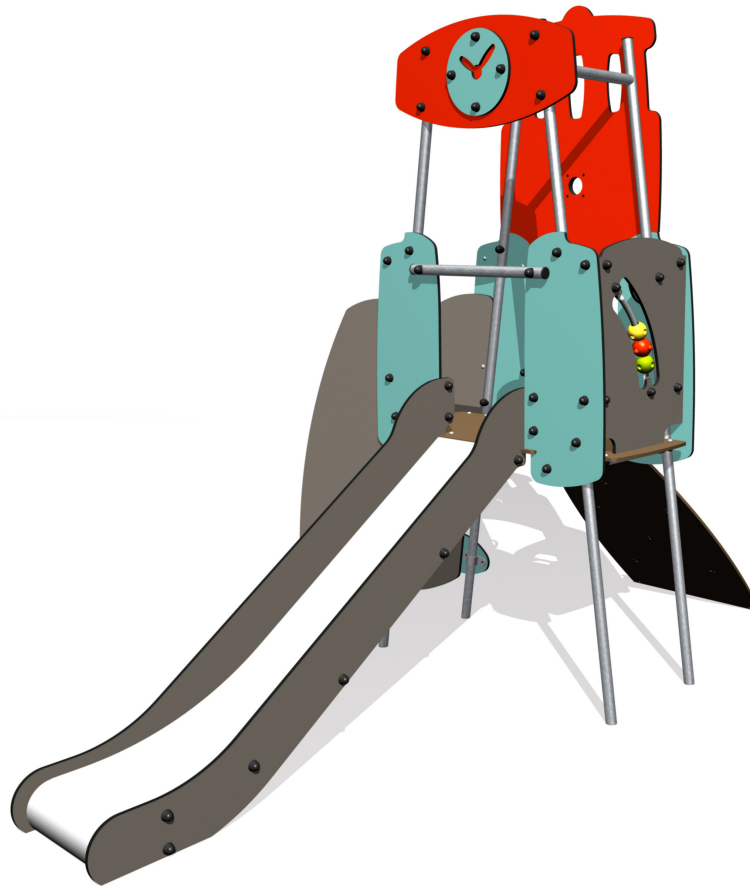



Play value :

8



climbing	role play	sliding	meeting	handling	visual stimulation	climbing
						
x1	x1	x1	x2	x1	x1	x1

Installation of equipment

IMPORTANT: It is essential to refer to the installation instructions for information on the size of the safety areas.

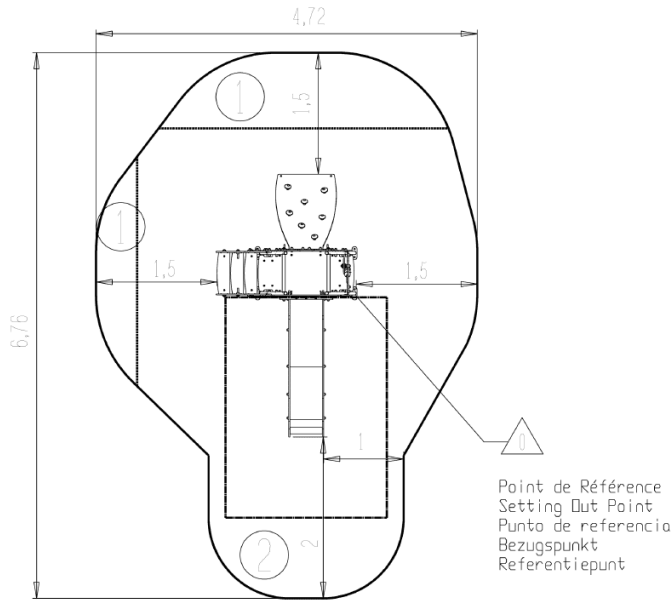
-  Impact area (minimum normative surface)
-  Free space



		
1	0,6m	3,5m ²
2	1m	20m ²



2



03h00



0m³



24m²



169kg



14kg

