

 **3+**
 **15**
 **1,77m**







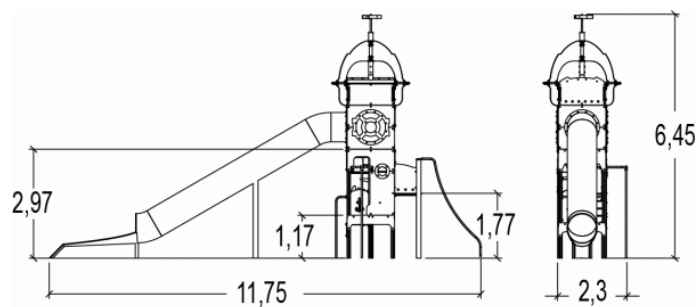
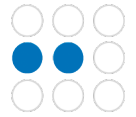

 1 = 11,75m
 2 = 2,3m
 3 = 6,45m



Physical inclusion
Sensory inclusion
Cognitive inclusion





Play value : **12**



role play	sliding	meeting	hiding	taking shelter	visual stimulation	climbing
						
x2	x3	x1	x1	x1	x2	x2

Installation of equipment

IMPORTANT: It is essential to refer to the installation instructions for information on the size of the safety areas.

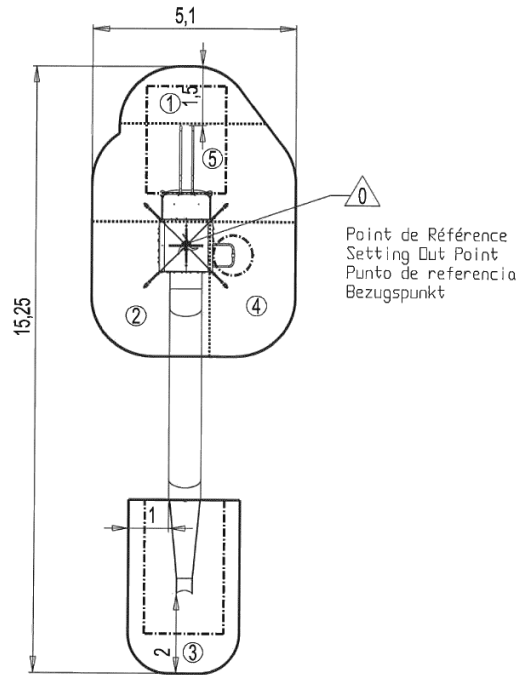
-  Impact area (minimum normative surface)
-  Free space



		
1	0,6m	4m ²
2	0,97m	9,5m ²
3	1m	12m ²
4	1,17m	7m ²
5	1,77m	12m ²



4



99h00



2.7m³



44.5m²



1609kg



700kg

