



4+



1



1m



1 = 6,11m
2 = 3,34m
3 = 3,3m



Physical inclusion
Sensory inclusion
Cognitive inclusion

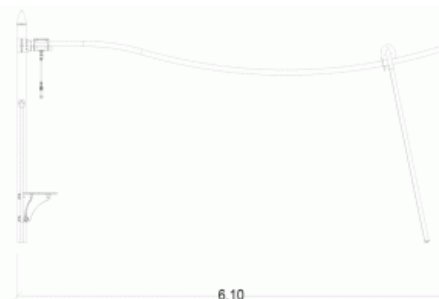
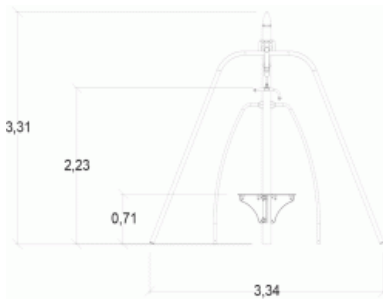
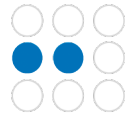

Play value : **3**

sliding



x1

meeting



x1



getting across



x1



Installation of equipment

IMPORTANT: It is essential to refer to the installation instructions for information on the size of the safety areas.

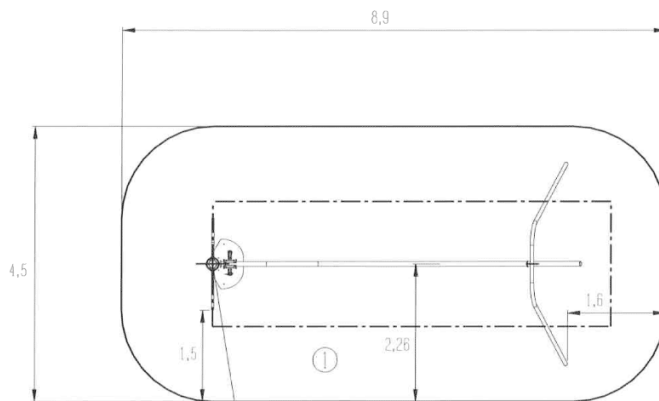
-  Impact area (minimum normative surface)
-  Free space



Point de Référence
Setting Out Point
Punto de referencia
Bezugspunkt

		
1	1m	39m ²



2



10h00



0.2m³



39m²



116kg



42kg

