

5 64 003 0

## Basis Integration carousel Ø 2,73 m







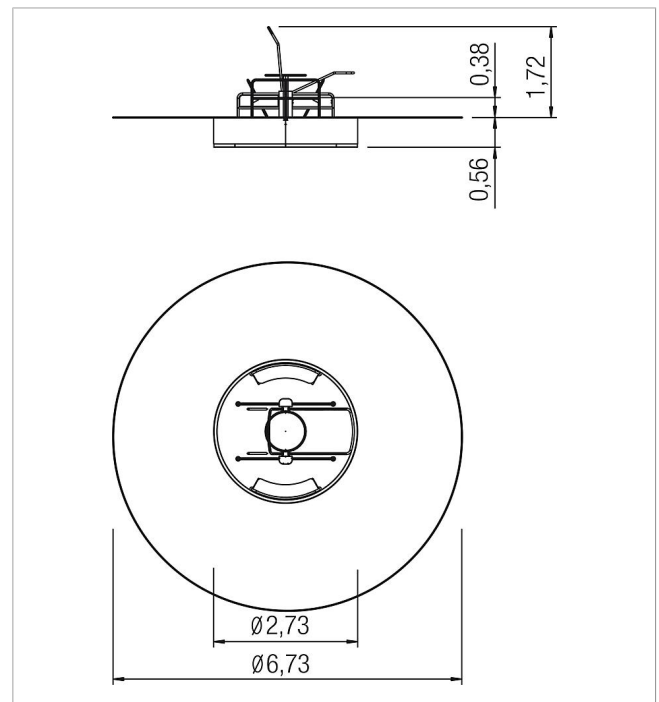

made in germany



### Scope of delivery

base structure: stainless steel  
1x mounting panel: galvanised steel  
seats: HPL  
1x bearing: ball/conical roller bearing  
bottom plate: galvanised steel



	Material	Stainless steel
	Foundation level	ET 580
	Minimum space	Ø 6,73x2,44 m
	Free falling height	80 cm
	Impact protection net	36,0 m <sup>2</sup>
	Foundations	1x CF
	Assembly	2 persons/3 h
	Largest section	Ø 261x140 cm
	Heaviest section	450 kg