

5 55 358 024

unique tarzan swing with seat







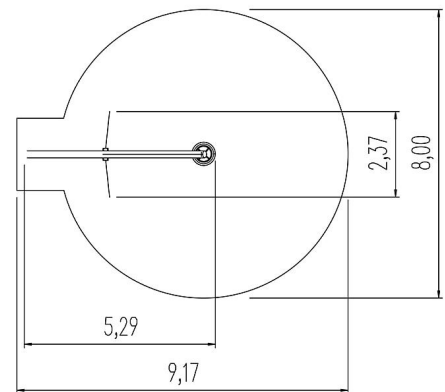
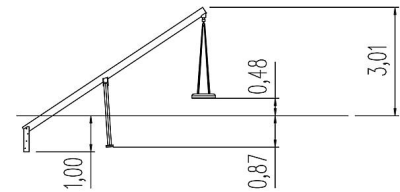

made in germany



Scope of delivery

- 1x carrying beam: galvanised and powder-coated steel
- 1x swing seat with chain galvanised steel
- 2x supporting post: galvanised and powder-coated steel
- 1x multiple-point suspension: stainless steel



	Material	powdered steel
	Foundation level	ET 870
	Minimum space	9,17x8,00x3,89 m
	Free falling height	160 cm
	Impact protection net	66,0 m ²
	Foundations	3x CF
	Assembly	3 persons/3 h
	Largest section	600x30x20 cm
	Heaviest section	150 kg