

Physical inclusion  
Sensory inclusion  
Cognitive inclusion

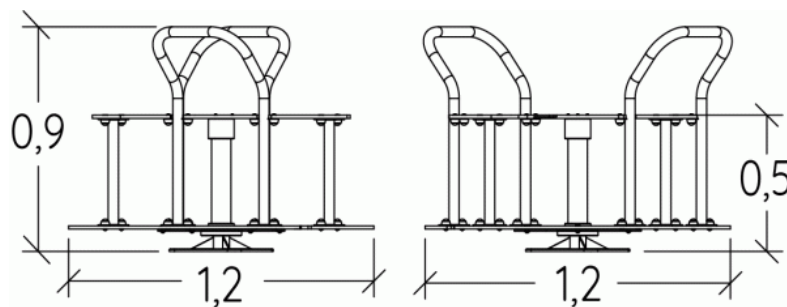

**Play value :**      **3**

meeting

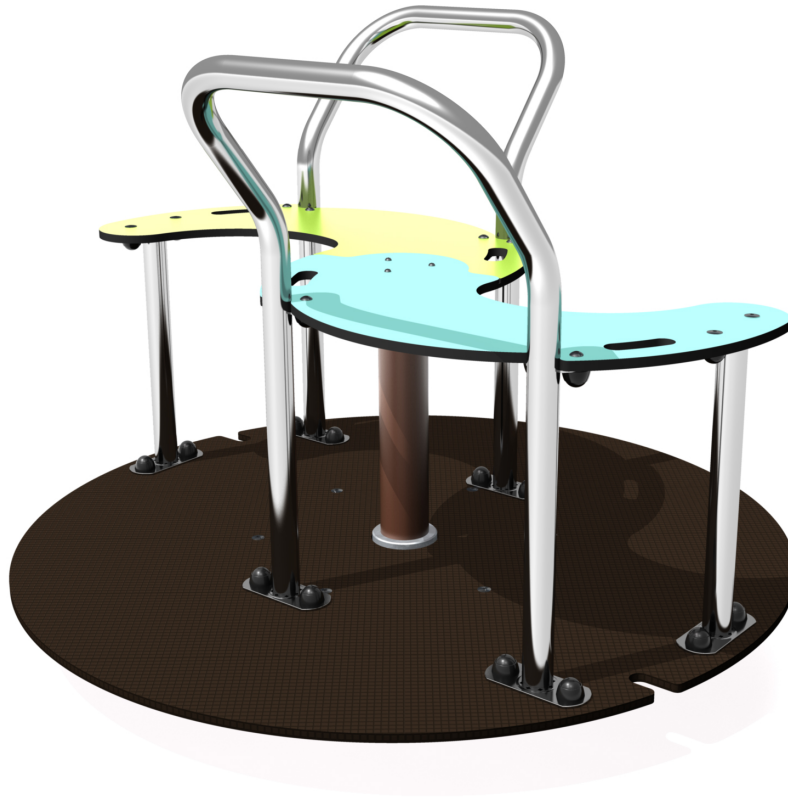

x1

balancing



x1



rotating





x1

## Installation of equipment

**IMPORTANT:** It is essential to refer to the installation instructions for information on the size of the safety areas.

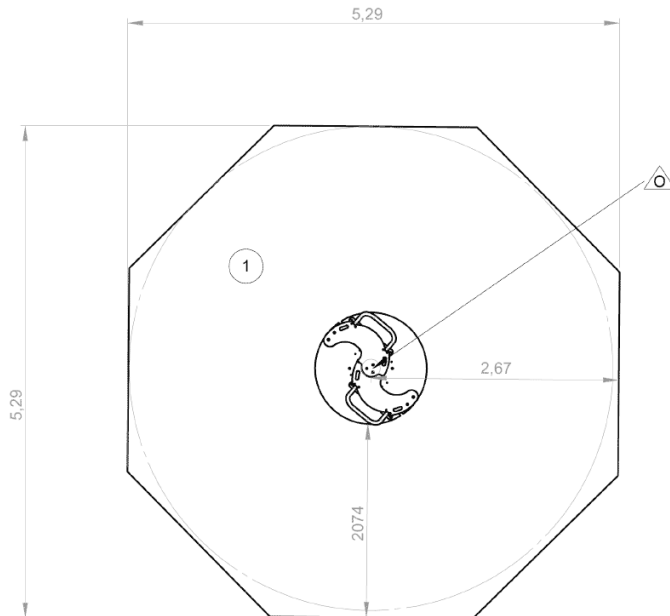
-  Impact area (minimum normative surface)
-  Free space



		
1	1m	23m <sup>2</sup>



1



03h00



0.3m<sup>3</sup>



23m<sup>2</sup>



94kg



83kg

