



6+



12



2,5m



1 = 4,07m  
2 = 3,51m  
3 = 3,4m



Physical inclusion  
Sensory inclusion  
Cognitive inclusion

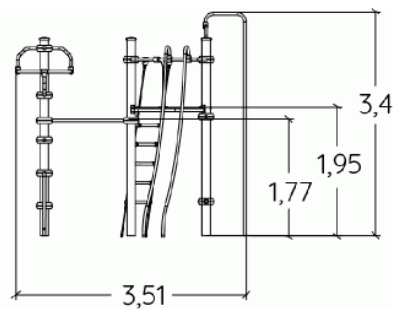
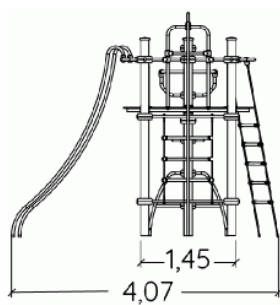
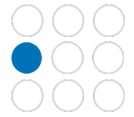

Play value :

9

sliding



x2

meeting



x1

resting



x1

hanging



x1

balancing



x1

climbing



x3

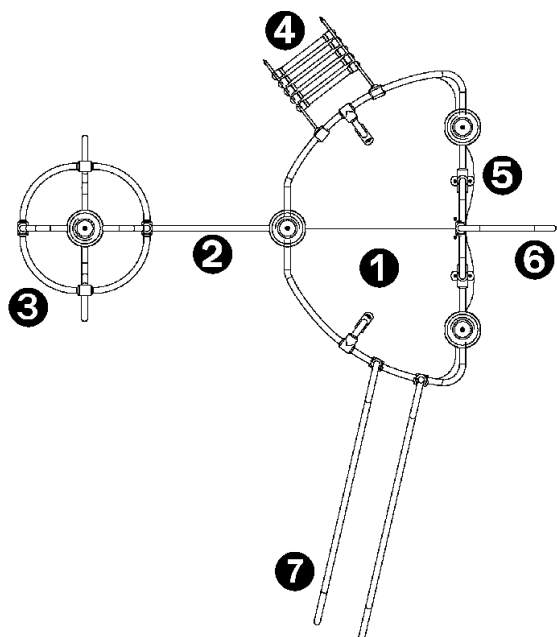

## Components



- ① Tour Gamma
- ② Barre fixe
- ③ Mât de vigie
- ④ Rope ladder
- ⑤ Echelle droite delta
- ⑥ Fireman's pole
- ⑦ Speed slide

## Installation of equipment

**IMPORTANT:** It is essential to refer to the installation instructions for information on the size of the safety areas.

-  Impact area (minimum normative surface)
-  Free space

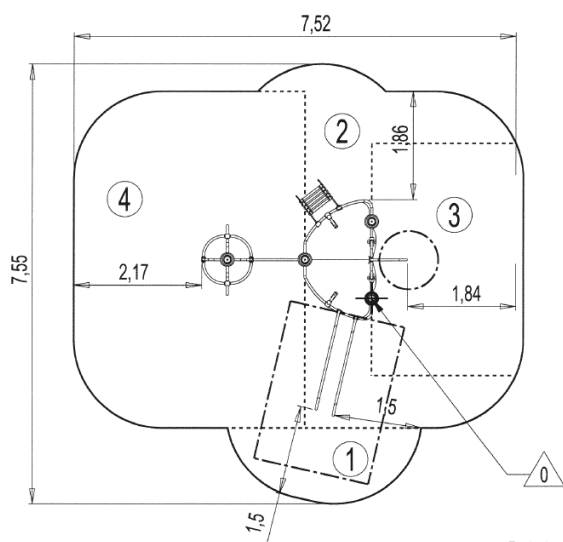

Point de Référence  
Setting Out Point  
Punto de referencia  
Bezugspunkt  
Referentiepunt



1	0,6m	3,5m <sup>2</sup>
2	1,95m	11m <sup>2</sup>
3	2,2m	10,5m <sup>2</sup>
4	2,5m	22m <sup>2</sup>



2



12h00



0.6m<sup>3</sup>



47m<sup>2</sup>



200kg



15kg

EN

1176