

5 55 364 024

unique double Curver







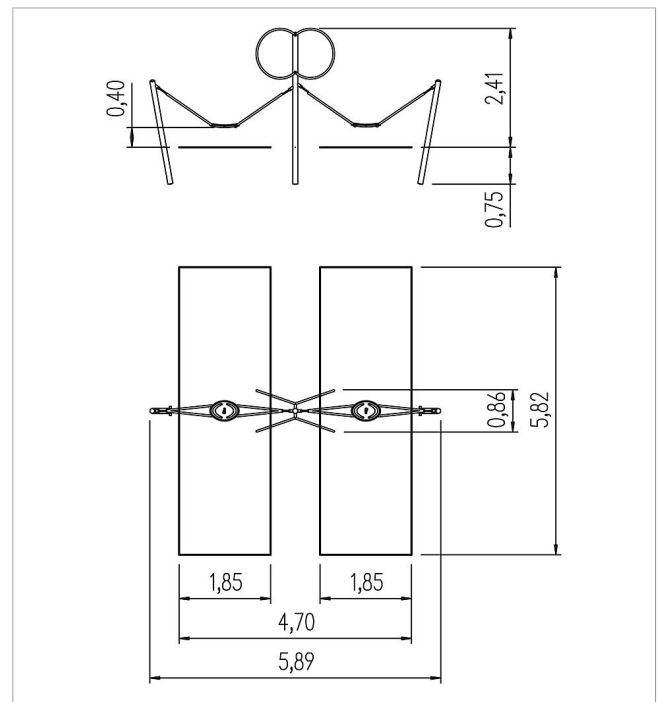

made in germany



Scope of delivery

- 3x posts: galvanised and powder-coated steel
- 2x chain: galvanised steel
- 4x joint: stainless steel
- 2x curver seat: rubber, galvanised steel
- 4x holding bracket: stainless steel



	Material	powdered steel
	Foundation level	ET 800
	Minimum space	6,10x3,41x2,65 m
	Free falling height	85 cm
	Impact protection net	21,5 m ²
	Foundations	3x CF
	Assembly	2 persons/2.5 h
	Largest section	312x160x86 cm
	Heaviest section	90 kg