

5 56 072 0

Basis Whizzer Saturn Ø 2,45 m







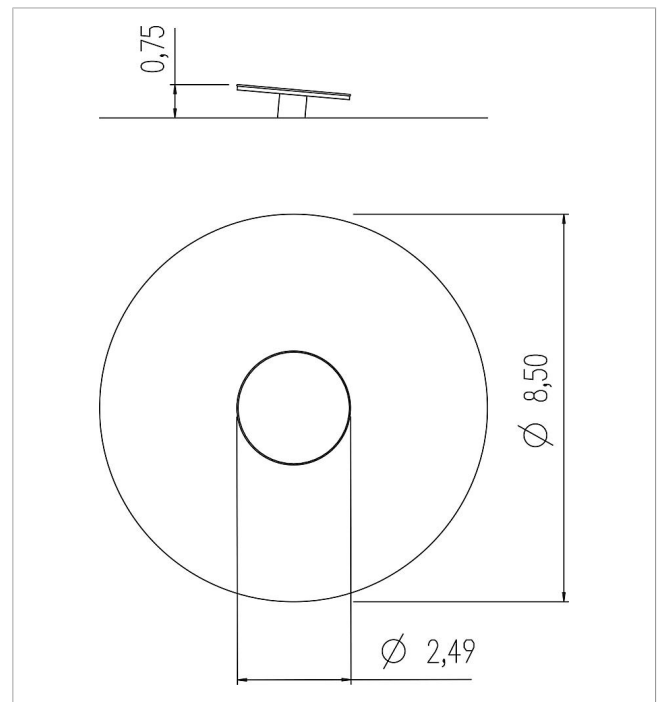

made in germany



Scope of delivery

- 1x turntable Ø 250 cm, visible parts of stainless steel, frame structure hot-dip galvanised, lining rubber
- 1x bearing ball/conical roller bearings sealed, low-maintenance
- 1x ground anchor hot-dip galvanised



	Material	stainless steel, rubber
	Foundation level	ET 770
	Minimum space	Ø 8,50x2,72 m
	Free falling height	72 cm
	Impact protection net	57,0 m ²
	Foundations	1x CF
	Assembly	2 persons/2 h
	Largest section	249x250x73 cm
	Heaviest section	200 kg