

5 56 087 0

Basis Turntable Saturn Ø 2,00 cm







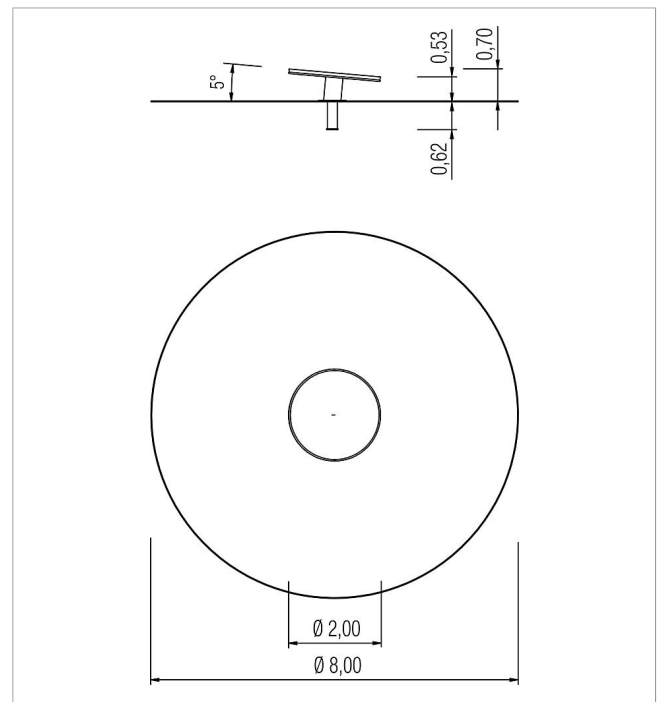

made in germany



Scope of delivery

1x turntable: stainless steel, rubber
1x frame: steel hot-dip galvanised



	Material	stainless steel, rubber
	Foundation level	ET 770
	Minimum space	Ø 8,00x2,35 m
	Free falling height	70 cm
	Impact protection net	50,5 m ²
	Foundations	1x CF
	Assembly	2 persons/6 h
	Largest section	205x205x30 cm
	Heaviest section	150 kg