

5 60 030 0

Basis Park bench Monika







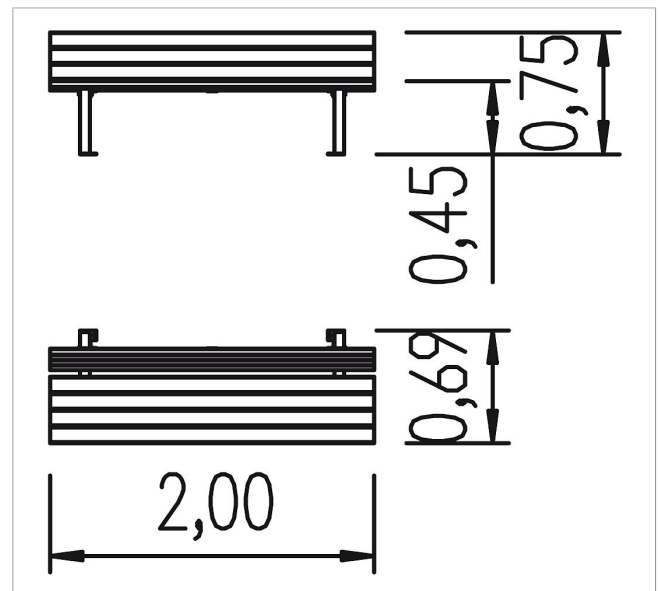

made in germany



Scope of delivery

2x bench frame: galvanised steel
1x seat board: SW glazed
1x backrest: SW glazed



	Material	Steel galv., SW glazed
	Foundation level	-
	Minimum space	2,00x0,69x0,75 m
	Free falling height	45 cm
	Impact protection net	-
	Foundations	4x CF
	Assembly	1 person/1 h
	Largest section	-
	Heaviest section	-