

5 11 059 011 00

playo climbing unit Cayambe







made in germany

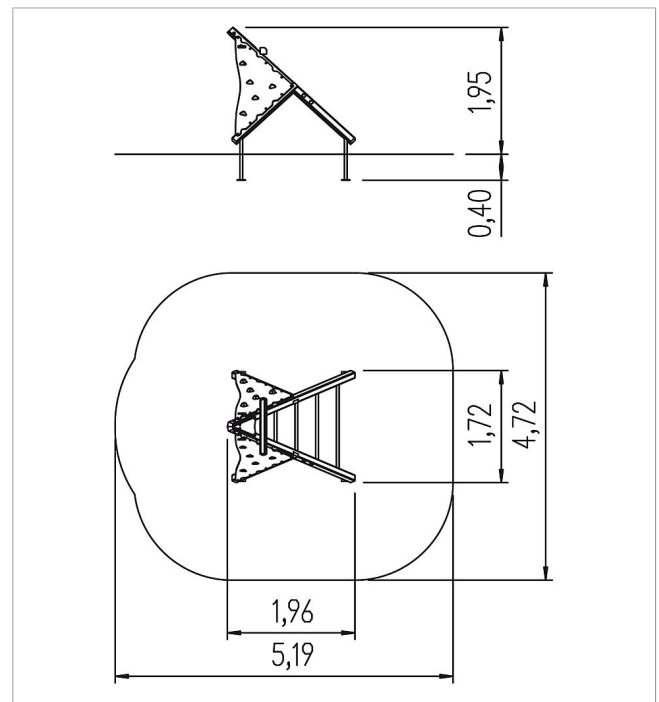

Scope of delivery

1x climbing panel with grips: HPL, GFRP
 1x climbing panel w/ grip holes: HPL
 1x reinforcement panel: HPL
 4x rung: stainless steel
 wood construction: SW
 post shoe: galvanised steel



	Material	SW pi
	Foundation level	ET 400
	Minimum space	5,19x4,72x3,75 m
	Free falling height	195 cm
	Impact protection net	22,0 m ²
	Foundations	4x CF or 4x PFs
	Assembly	2 persons/2 h