

Physical inclusion  
Sensory inclusion  
Cognitive inclusion

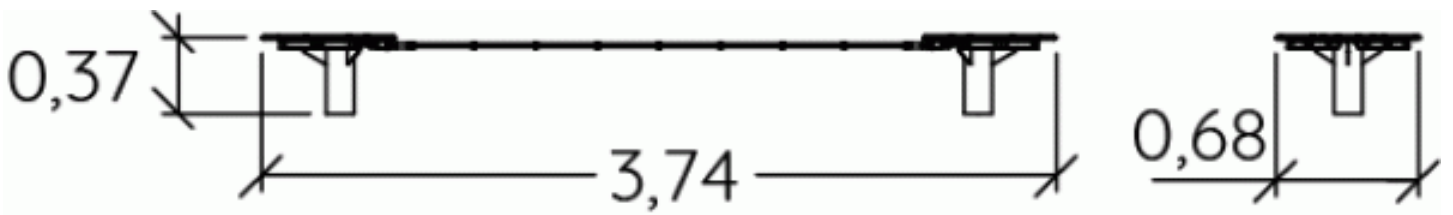

Play value : 2

balancing getting across



x1



x1

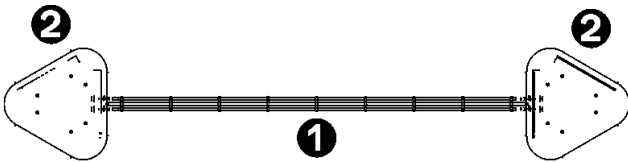

## Components

- ① Slackline
- ② Stool





## Installation of equipment

**IMPORTANT:** It is essential to refer to the installation instructions for information on the size of the safety areas.

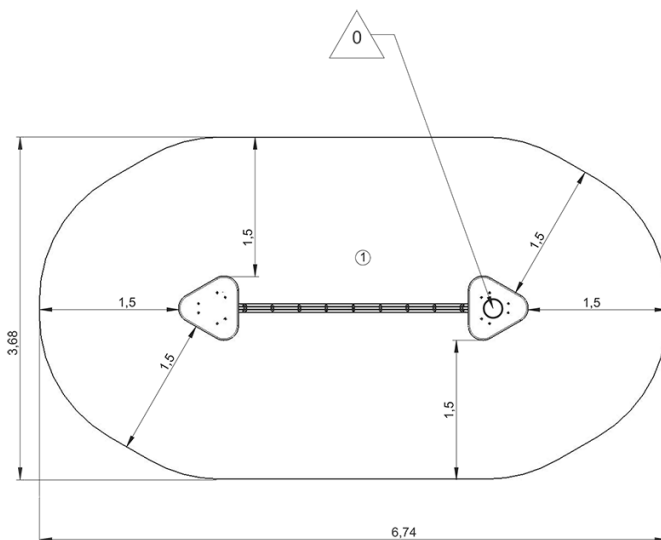
-  Impact area (minimum normative surface)
-  Free space



1	 <0,6m	 22m <sup>2</sup>
---	---	--



2



04h00



0.5m<sup>3</sup>



23m<sup>2</sup>



49kg



14kg

