

 **8+**  
 **28**  
 **3m**

  
 1 = 13,82m  
 2 = 3,28m  
 3 = 3,4m



Physical inclusion  
Sensory inclusion  
Cognitive inclusion

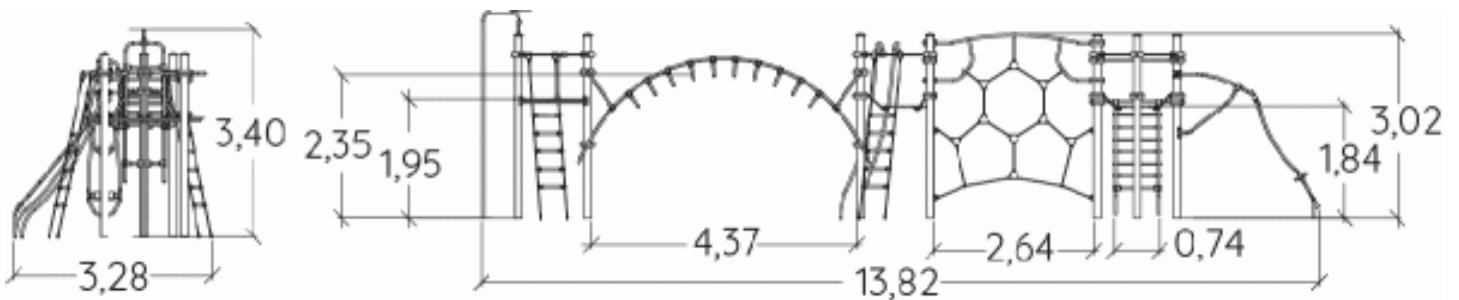
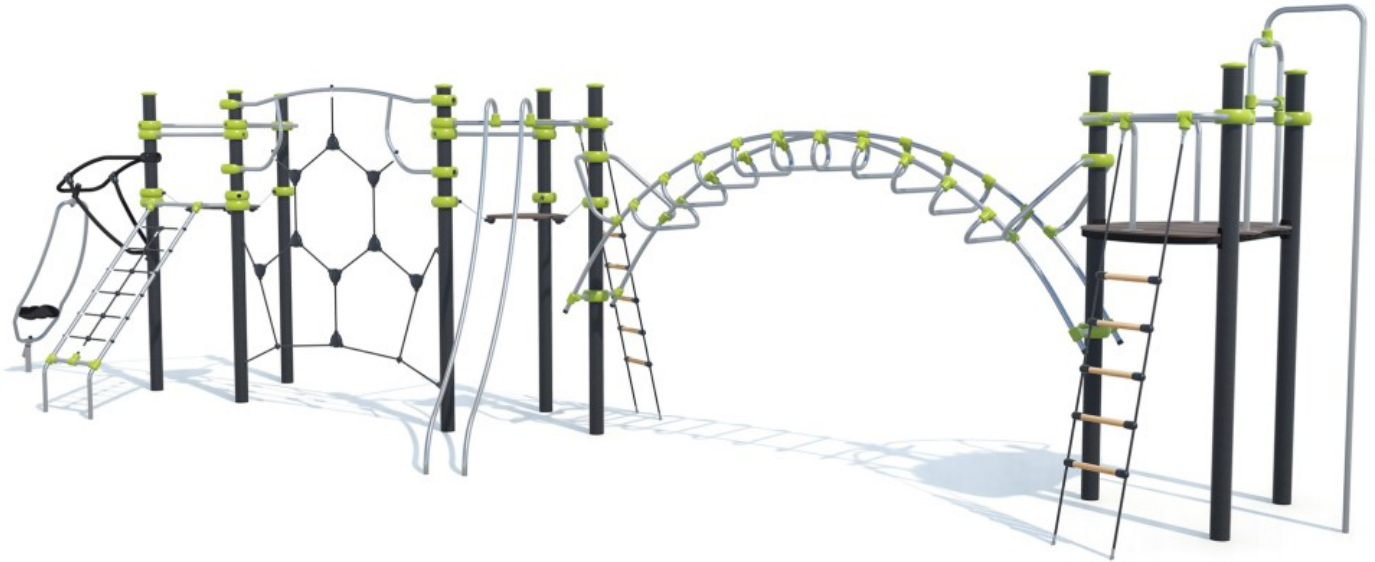
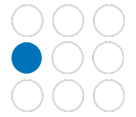

**Play value :** **16**

sliding



x2

meeting



x3

hanging



x1

balancing



x3

rotating



x1

climbing



x4

getting across



x2

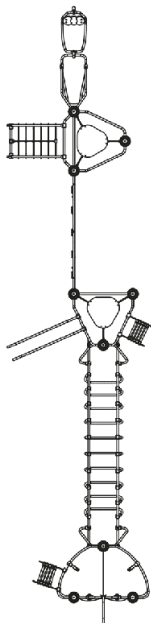

## Components



- ❶ Tour Gamma
- ❷ Tour Delta
- ❸ Great arch
- ❹ Net IXO
- ❺ Fireman's pole
- ❻ Rope ladder
- ❼ Speed slide
- ❽ Delta Incline net
- ❾ Gyro

## Installation of equipment

**IMPORTANT:** It is essential to refer to the installation instructions for information on the size of the safety areas.

-  Impact area (minimum normative surface)
-  Free space

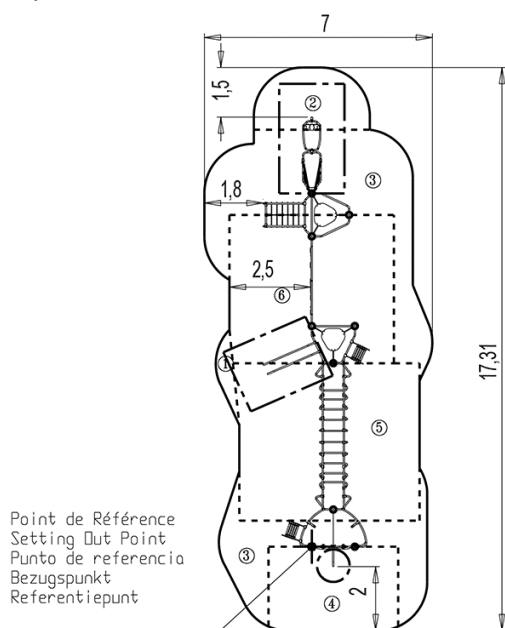

1	0,6m	1m <sup>2</sup>
2	0,7m	6m <sup>2</sup>
3	1,95m	30m <sup>2</sup>
4	2,2m	10,5m <sup>2</sup>
5	2,4m	27m <sup>2</sup>
6	3m	23m <sup>2</sup>



2



24h00



1.4m<sup>3</sup>



97.5m<sup>2</sup>



418kg



54kg

