

 **2+**
 **20**
 **1,17m**



 1 = 3,84m
 2 = 2,98m
 3 = 2,58m



Physical inclusion
Sensory inclusion
Cognitive inclusion

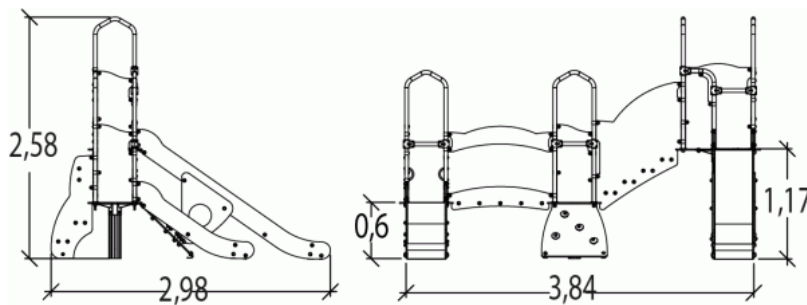
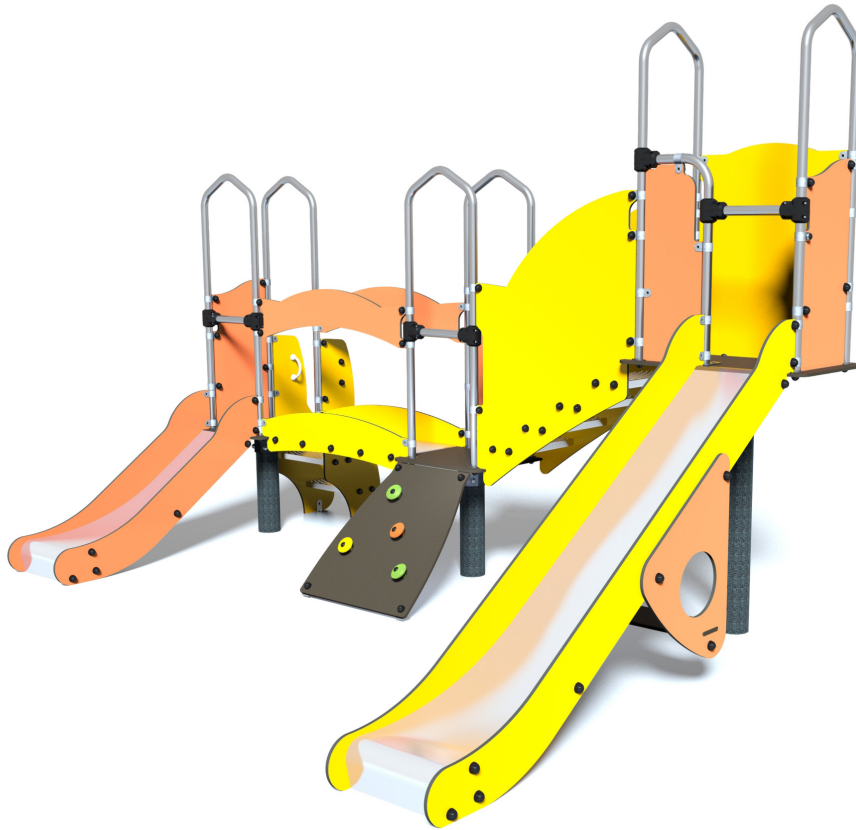

Play value : **11**

climbing



x1

sliding



x2

meeting



x3

resting



x1

hiding



x1

climbing



x2

getting across



x1

Components

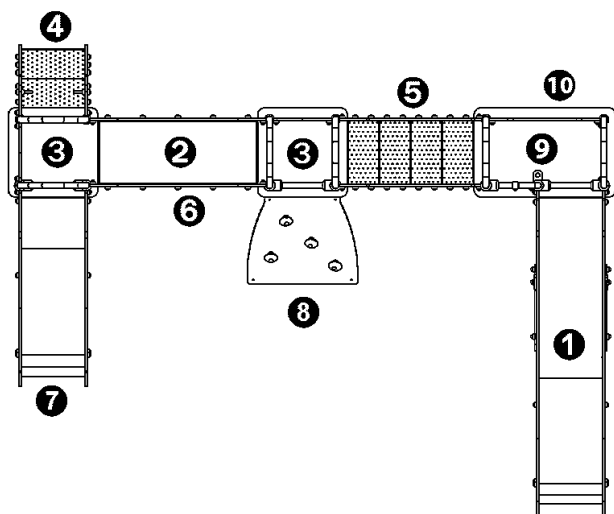

- ❶ Slide HT: 1.17m
- ❷ Walkway
- ❸ Platform HT: 0.6m
- ❹ Steps
- ❺ Connecting staircase
- ❻ Wall
- ❼ Slide HT: 0.6m
- ❽ Slope
- ❾ Platform HT: 1.17m
- ❿ Grande balustrade
- ⓫ Balustrade éléments

Installation of equipment

IMPORTANT: It is essential to refer to the installation instructions for information on the size of the safety areas.

- Impact area (minimum normative surface)
- Free space

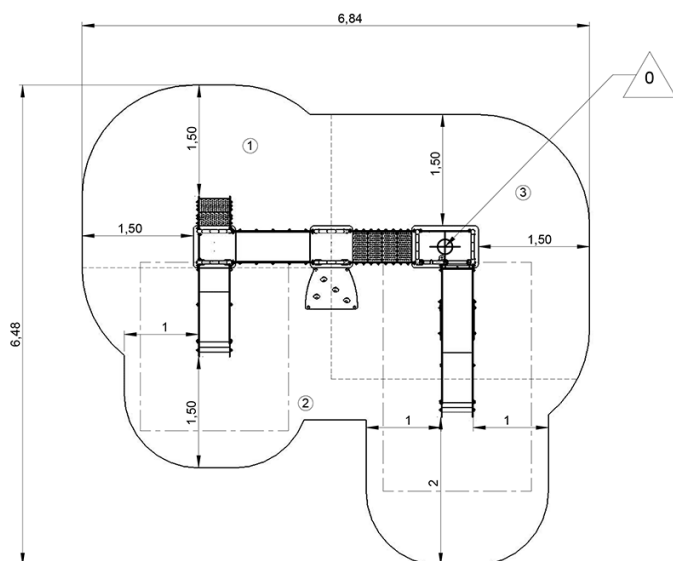

1	0,6m	8m ²
2	1m	13,5m ²
3	1,17m	12m ²



2



12h00



0.4m³



33.5m²



299kg



17kg

EN

1176