

5 20 023 011 04

unique carriage







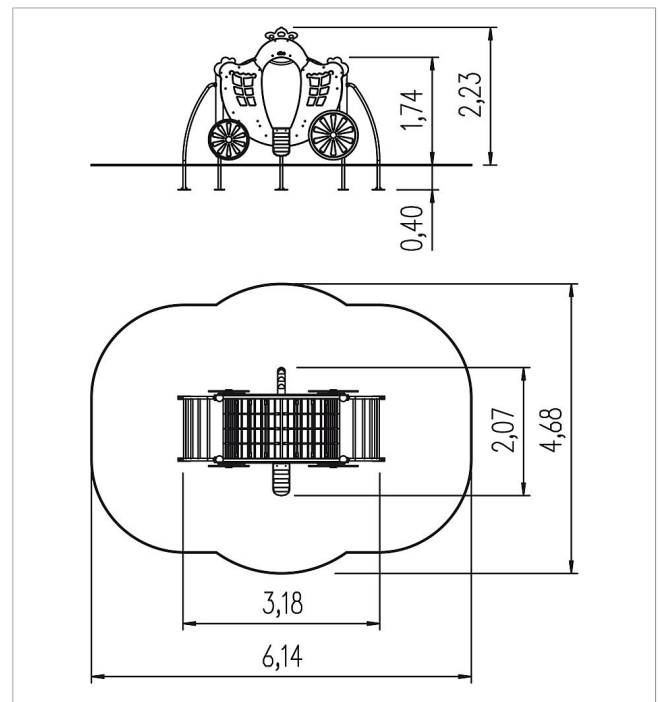

made in germany



### Scope of delivery

- 4x posts with post bases: SW, post bases galvanised with ball covers
- 1x set motive panels coach: HPL
- 1x climbing net bend: plastic-coated steel cable, galvanised and powder-coated steel
- 2x bend climb access: stainless steel
- 1x stem access: SW
- 1x access ramp: HPL, SW
- 4x turning wheels: HPL



	Material	SW pi
	Foundation level	ET 400
	Minimum space	6,14x4,68x3,61 m
	Free falling height	180 cm
	Impact protection net	24,0 m <sup>2</sup>
	Foundations	6x CF or 6x PFs
	Assembly	2 persons/4 h
	Largest section	190x108x48 cm
	Heaviest section	70 kg