

5 55 091 5

unique four-seater seesaw







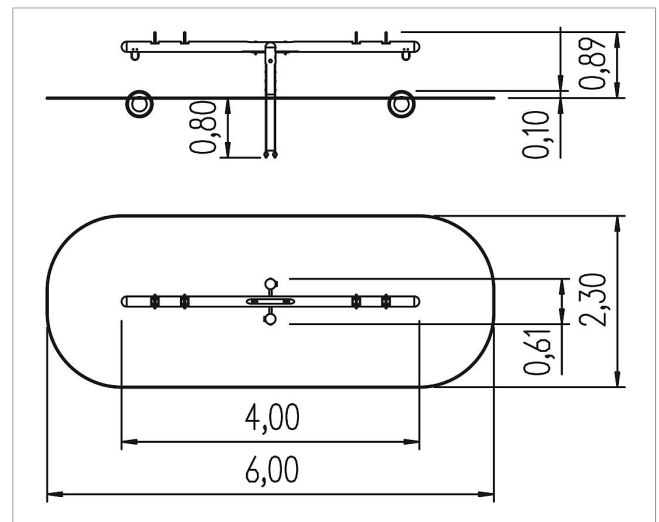

made in germany



Scope of delivery

1x see-saw beam: SW
2x see-saw posts: SW
4x handle: stainless steel
2x tyres: rubber
post shoes: galvanised steel



	Material	SW pi
	Foundation level	ET 800
	Minimum space	6,00x2,30x2,90 m
	Free falling height	110 cm
	Impact protection net	13,0 m ²
	Foundations	1x CF
	Assembly	2 persons/2 h
	Largest section	Ø 16x400 cm
	Heaviest section	60 kg