

5 67 219 0

Basis Spring rocker Recliner







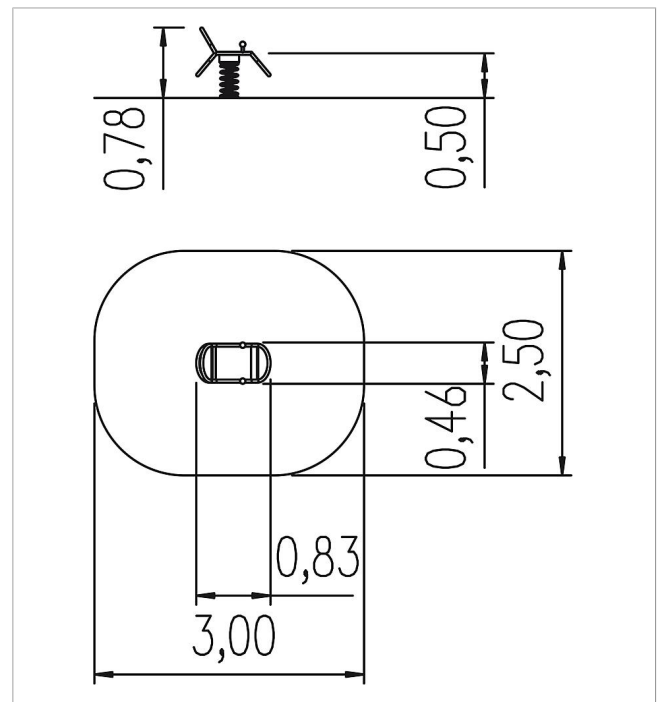

made in germany



Scope of delivery

1x frame: stainless steel
1x spring: spring steel



	Material	Stainless steel
	Foundation level	FL 0
	Minimum space	3,00x2,50x2,33 m
	Free falling height	50 cm
	Impact protection net	7,5 m ²
	Foundations	1x 5632280 + 1x CF
	Assembly	1 person/1 h
	Largest section	83x46x54 cm
	Heaviest section	30 kg