

5 67 222 0

## Basis Spring rocker Stand-up







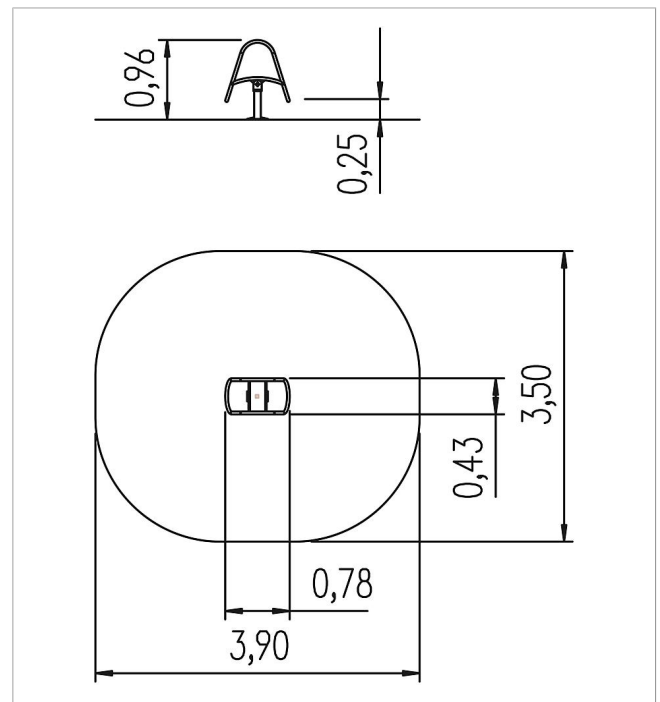

made in germany



### Scope of delivery

1x frame: stainless steel  
1x rocker element



	Material	Stainless steel
	Foundation level	FL 3
	Minimum space	3,90x3,50x2,31 m
	Free falling height	51 cm
	Impact protection net	12,0 m <sup>2</sup>
	Foundations	1x 5632100 + 1x CF
	Assembly	1 person/1 h
	Largest section	73x43x76 cm
	Heaviest section	40 kg