



0.5+



19



1m









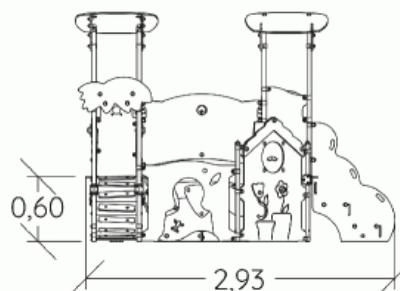
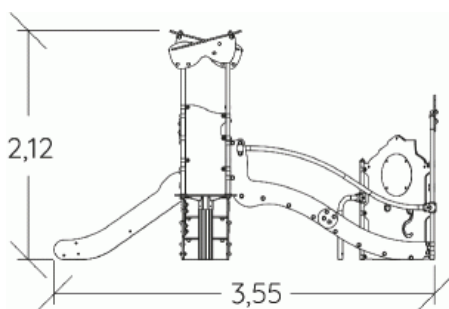



1 = 3,55m
2 = 2,93m
3 = 2,12m



Physical inclusion
Sensory inclusion
Cognitive inclusion

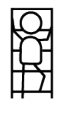

Play value : **27**

role play	sliding	meeting	handling	crawling	hiding	taking shelter	tactile stimulation
							
x2	x2	x4	x2	x3	x1	x2	x4
visual stimulation	climbing	getting across					
							
x2	x2	x3					

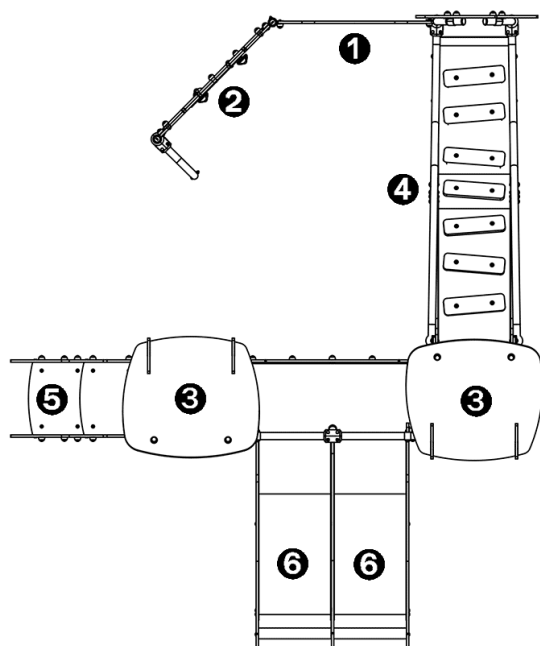

Components



- ① Panneau Silhouette
- ② Panneau Haut Maisonnette
- ③ Platform HT: 0.6m
- ④ Baby Access Ramp
- ⑤ Baby access steps
- ⑥ Double slide

Installation of equipment

IMPORTANT: It is essential to refer to the installation instructions for information on the size of the safety areas.

-  Impact area (minimum normative surface)
-  Free space

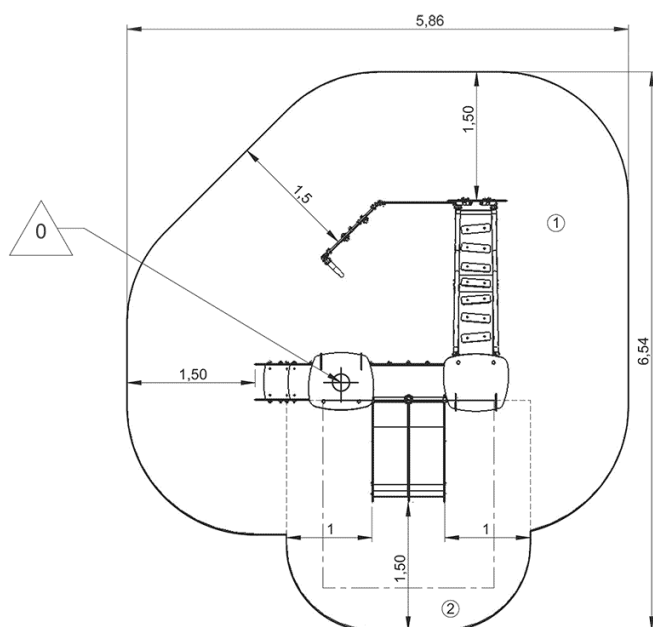

1	0,6m	23,5m ²
2	1m	7,5m ²



2

08h00

0.38m³

31m²

320kg

15kg

EN

1176