



2+



28



1,17m









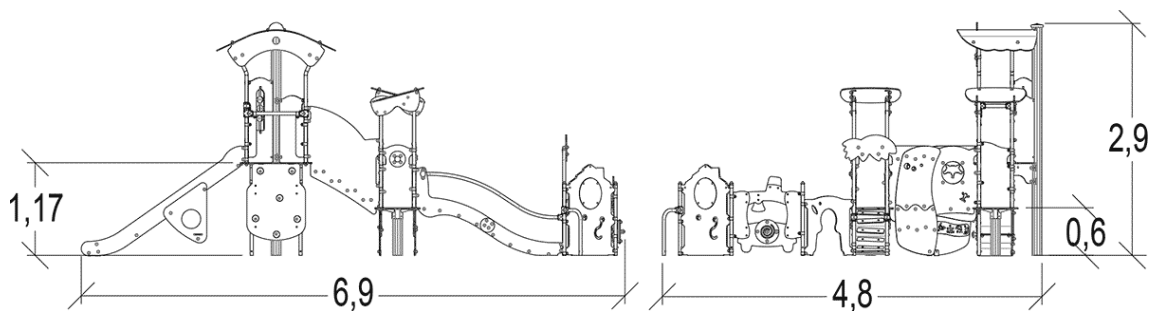







1 = 6,86m
2 = 4,81m
3 = 2,93m



Physical inclusion
Sensory inclusion
Cognitive inclusion

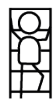

Play value : **45**

climbing	role play	sliding	meeting	resting	handling	crawling	hiding
							
x1	x3	x1	x6	x1	x4	x3	x2
taking shelter	thinking	sound stimulation	tactile stimulation	visual stimulation	climbing	getting across	
							
x3	x3	x1	x7	x4	x3	x3	

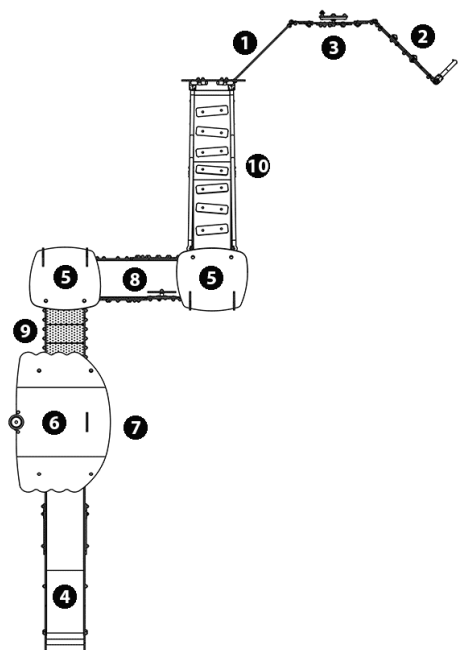

Components





- ❶ Panneau Silhouette
- ❷ Panneau Haut Maisonnette
- ❸ PANNEAU CITY SANS TUBE
- ❹ Slide HT: 1.17m
- ❺ Platform HT: 0.6m
- ❻ Tower HT: 1.17m
- ❼ Climbing wall
- ❽ Counting panel
- ❾ Compact (HPL) platform - The fox's hideaway
- ❿ Baby Access Ramp

Installation of equipment

IMPORTANT: It is essential to refer to the installation instructions for information on the size of the safety areas.

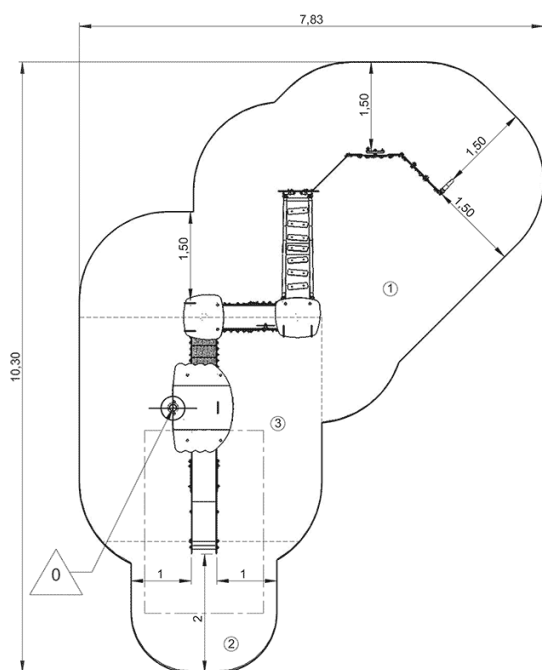
-  Impact area (minimum normative surface)
-  Free space



		
1	0,6m	26,5m ²
2	1m	5,5m ²
3	1,17m	15,5m ²



2

15h00

0.44m³

47.5m²

474kg

17kg

EN

1176