

3+ 1 0,6m

- 1 = 1,93m
- 2 = 1,32m
- 3 = 1,6m

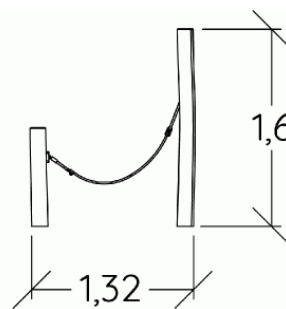

Physical inclusion  
Sensory inclusion  
Cognitive inclusion

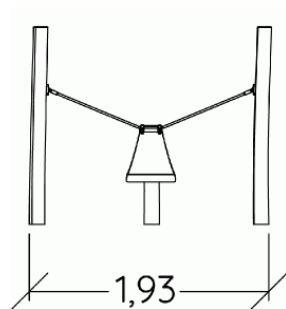
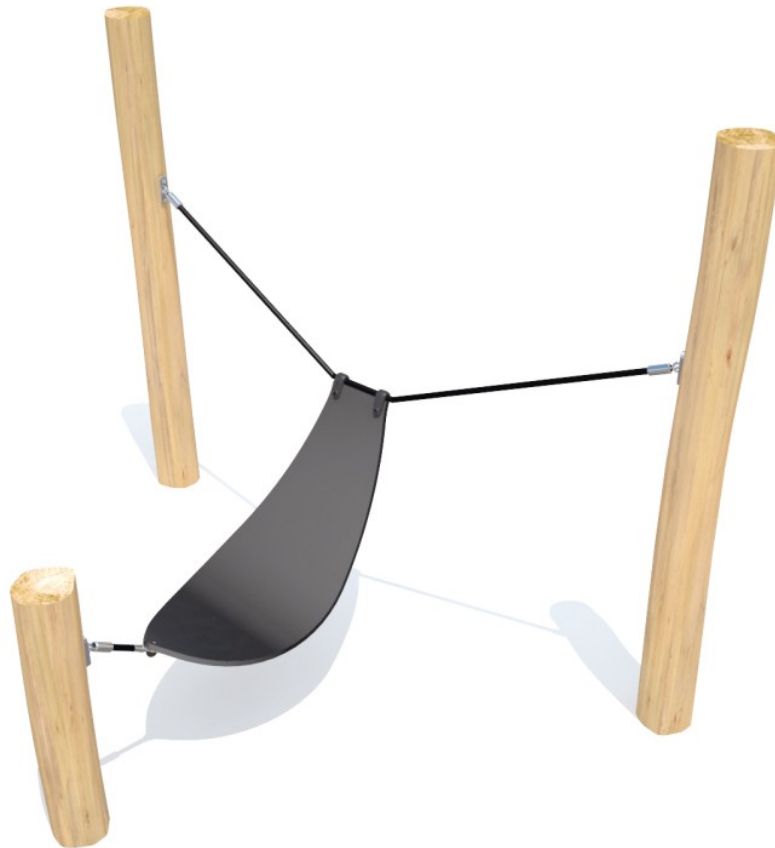
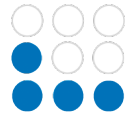

Play value : 2

resting



x1

swinging



x1

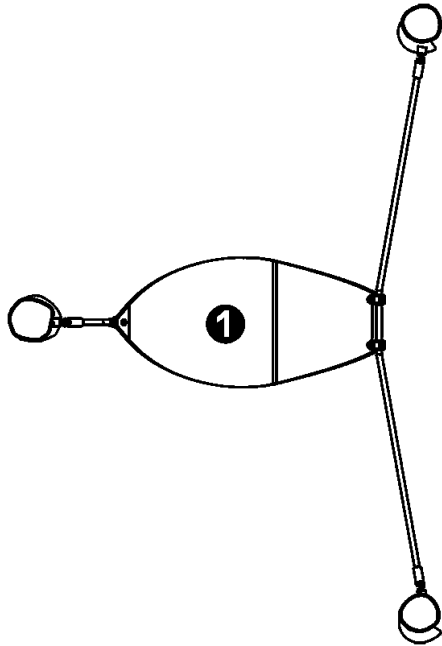

## Components





① Hammock

## Installation of equipment

**IMPORTANT:** It is essential to refer to the installation instructions for information on the size of the safety areas.

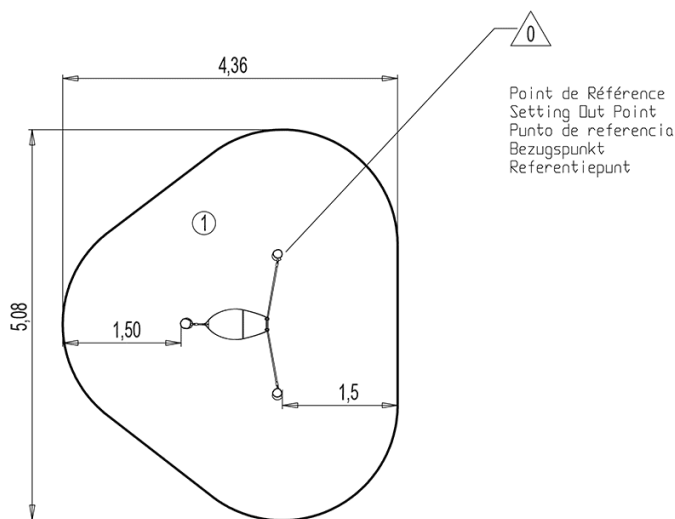
-  Impact area (minimum normative surface)
-  Free space



		
1	<0,6m	17m <sup>2</sup>



2



01h00



0.2m<sup>3</sup>



17m<sup>2</sup>



72kg



25kg

