



5 55 566 0

Basis Matterhorn







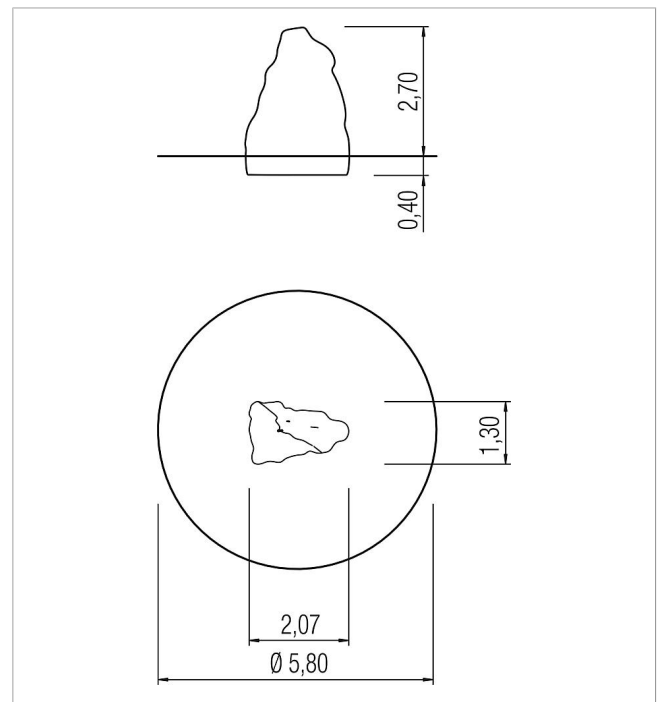

made in germany



Scope of delivery

1x Matterhorn incl. climbing holds: GFRP



	Material	GFRP
	Foundation level	FL 1
	Minimum space	Ø 5,80x4,50 m
	Free falling height	210 cm
	Impact protection net	25,5 m ²
	Foundations	4x CF or 4x PFs
	Assembly	3 persons/3 h
	Largest section	310x210x130 cm
	Heaviest section	150 kg