



2+



1



0,6m



1 = 1,15m  
2 = 0,4m  
3 = 0,7m



Physical inclusion  
Sensory inclusion  
Cognitive inclusion

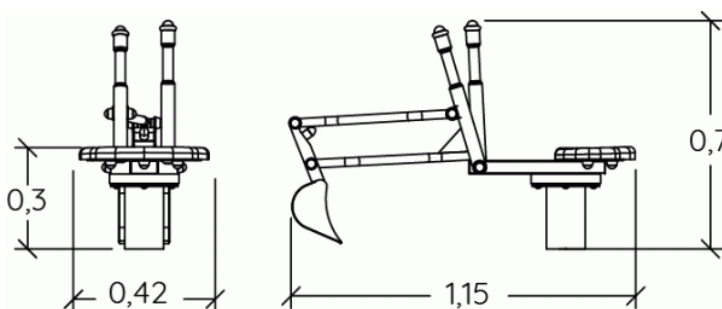

Play value :

5

role play



x1

resting



x1

handling



x1

thinking



x1

tactile stimulation



x1

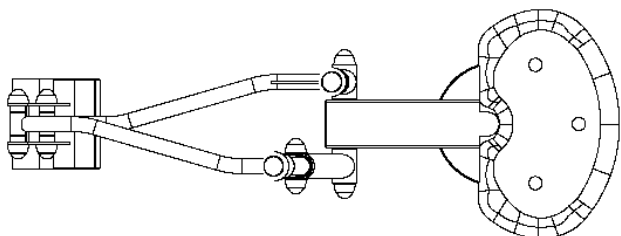

## Components

1 Digger





## Installation of equipment

**IMPORTANT:** It is essential to refer to the installation instructions for information on the size of the safety areas.

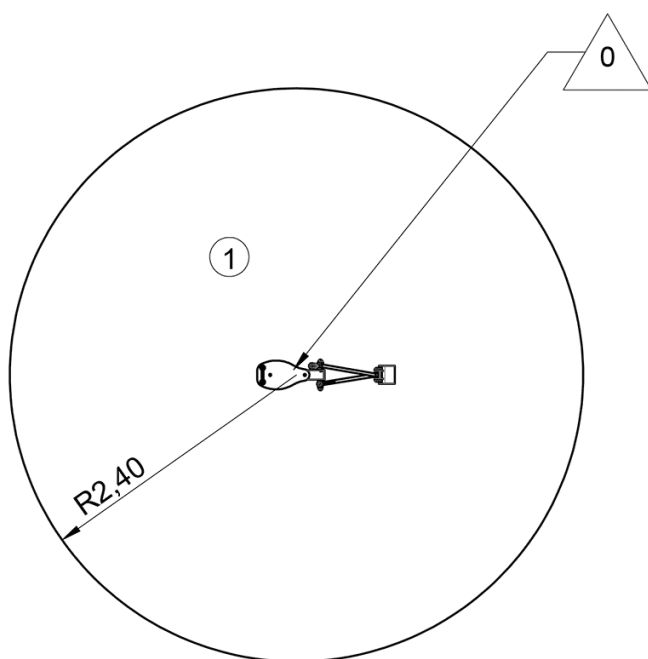
-  Impact area (minimum normative surface)
-  Free space



		
1	<0,6m	17m <sup>2</sup>



1

00h30

0.4m<sup>3</sup>

18m<sup>2</sup>

15kg

15kg

