

5 59 851 0010 0

minimondo play unit Butterfly







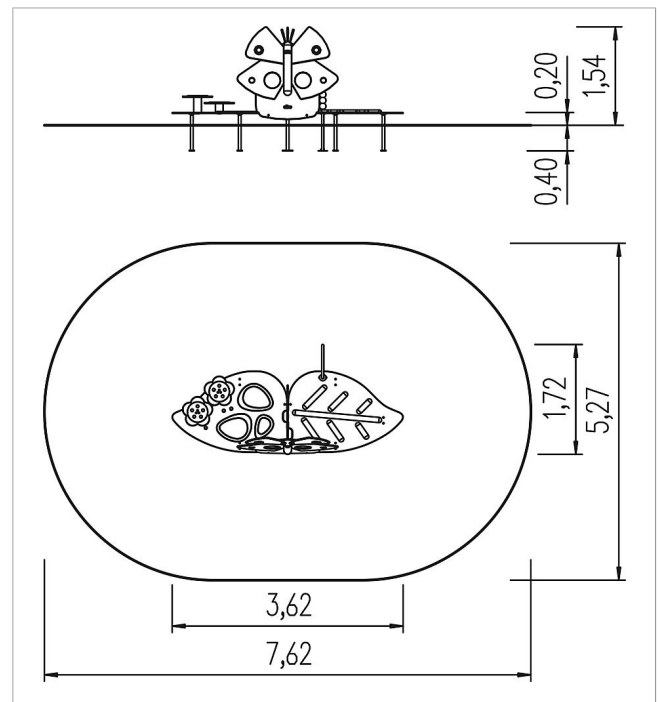

made in germany



Scope of delivery

- 1x leaf with hole: HPL
- 1x leaf left with half-round timber: HPL, SW
- 1x leaf right with lawn filling: HPL, plastic
- 1x leaf butterfly: HPL
- 1x butterfly body with filler: SW, plastic-coated steel cable
- 4x blades with Plexiglas filling: HPL, Plexiglas
- 1x marble arch with balls: stainless steel, plastic
- 2x flower: SW, HPL
- 8x stand base: hot-dip galvanised



	Material	SW pi
	Foundation level	FL 1
	Minimum space	762x527x200 cm
	Free falling height	20 cm
	Impact protection net	34,5 m ²
	Foundations	9x CF or 9x PFs or 9x PFr
	Largest section	188x127x5,5 cm
	Heaviest section	30 kg