

5 55 653 0

## Basis Seat and rest rock Kaiserstuhl







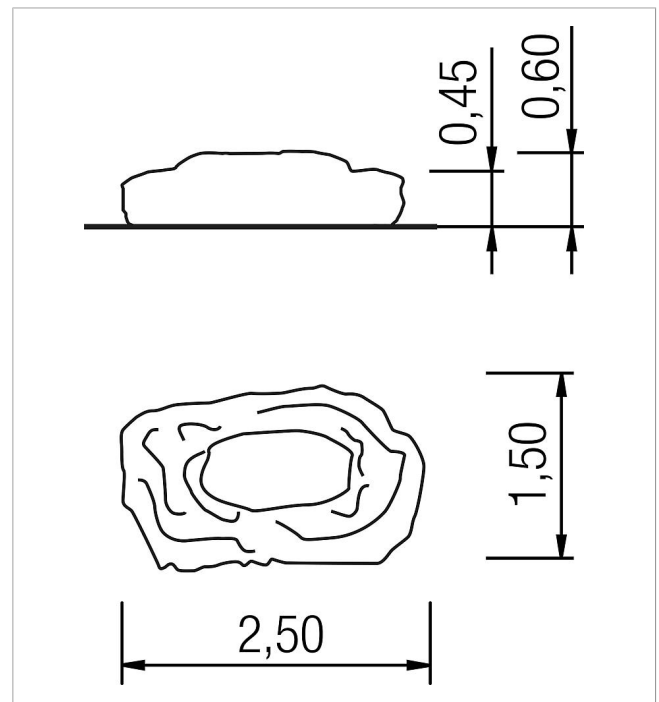

made in germany



### Scope of delivery

1x seat and rest rock: styrofoam, modelling matrix



|   |                       |                             |
|---|-----------------------|-----------------------------|
|  | Material              | Styrofoam, modelling matrix |
|  | Foundation level      | FL 1                        |
|  | Minimum space         | 2,50x1,50x0,00 m            |
|  | Free falling height   | 45 cm                       |
|  | Impact protection net | -                           |
|  | Foundations           | -                           |
|  | Assembly              | 2 persons/1 h               |
|  | Largest section       | 250x150x60 cm               |
|  | Heaviest section      | 1.500 kg                    |