

5 11 565 013 00

ecorino Sand construction site Grey- headed Woodpecker

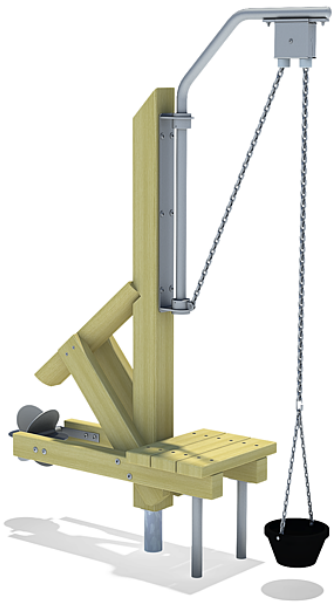





made in germany

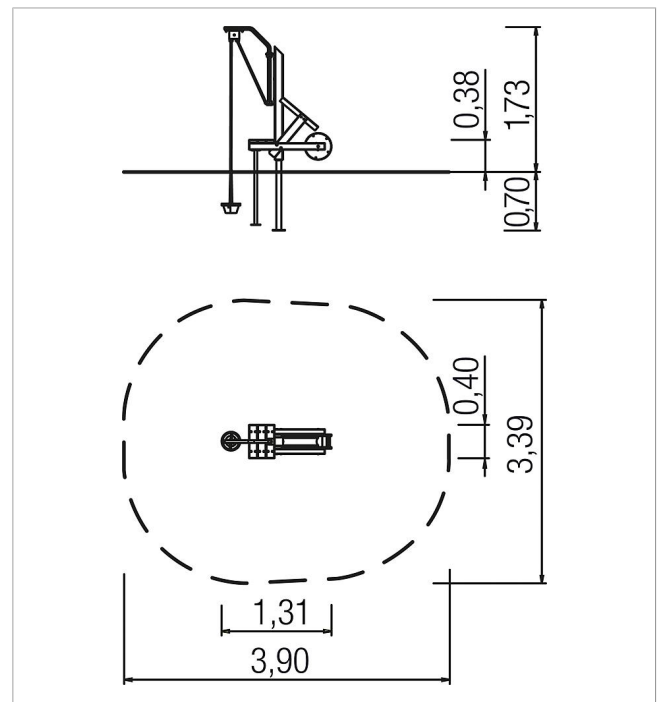

Scope of delivery

- 3x post construction: softwood or steel
- 1x platform construction: softwood
- 1x sand chute: softwood
- 1x sand lift: stainless steel (V2A)
- 1x sand wheel: stainless steel (V2A)



	Material	SW pi
	Foundation level	ET 700
	Minimum space	3,39x3,90x2,18 m
	Free falling height	38 cm
	Impact protection net	-
	Foundations	1x CF
	Assembly	2 persons/2 h