

5 25 075 041 00

unique play unit Lycon 1, solo







made in germany

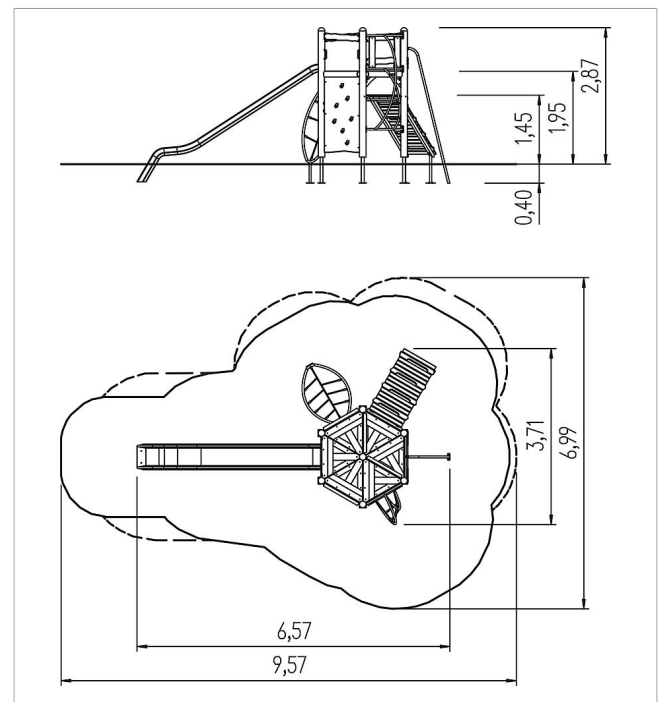

Scope of delivery

- 7x post construction: SW or steel
- 3x platform construction: galvanised steel
- 6x platform planks: SW
- 5x wall panel: SW
- 1x climber ramp: SW
- 1x leaf ascent: stainless steel, polyester-coated steel cable
- 1x fireman's pole: stainless steel
- 1x climbing wall: HPL, climbing grips
- 1x lavender ascent: stainless steel, polyester-coated steel cable, SW
- 1x slide entry plate: HPL
- 3x set of grips: steel
- 3x frame trim: SW



| | | |
|---|-----------------------|---------------------|
|  | Material | Larch GL, larch |
|  | Foundation level | FL 1 |
|  | Minimum space | 9,50x7,01x3,75 m |
|  | Free falling height | 195 cm |
|  | Impact protection net | 42,5 m ² |
|  | Foundations | 11x CF or 11x PFs |
|  | Assembly | 2 persons/7 h |