

Physical inclusion

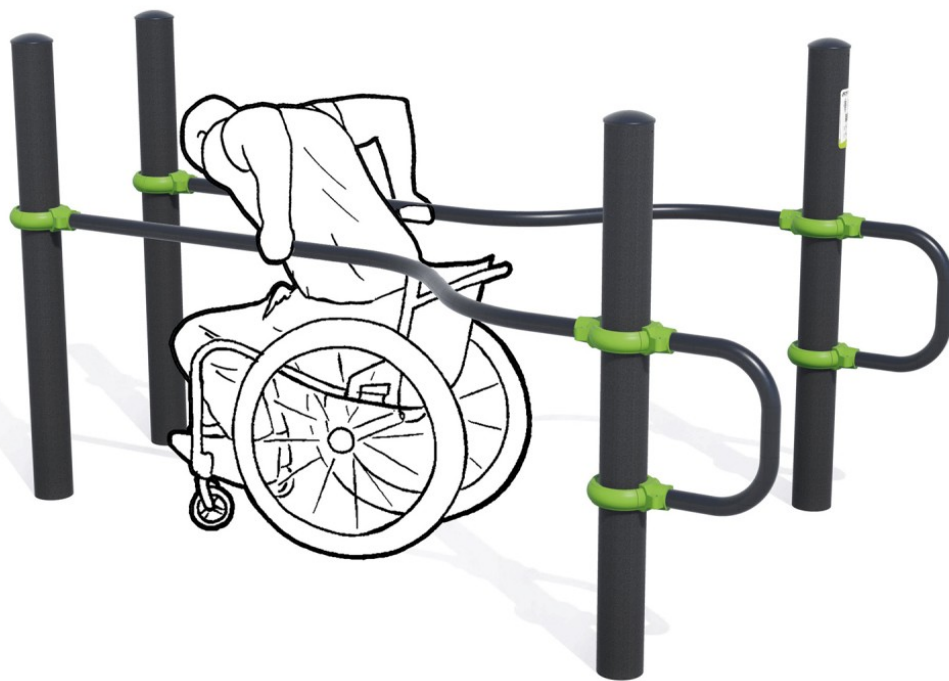

Sports formula

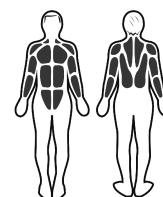

Muscular stimulation

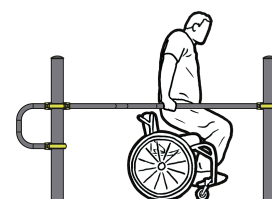

Movements

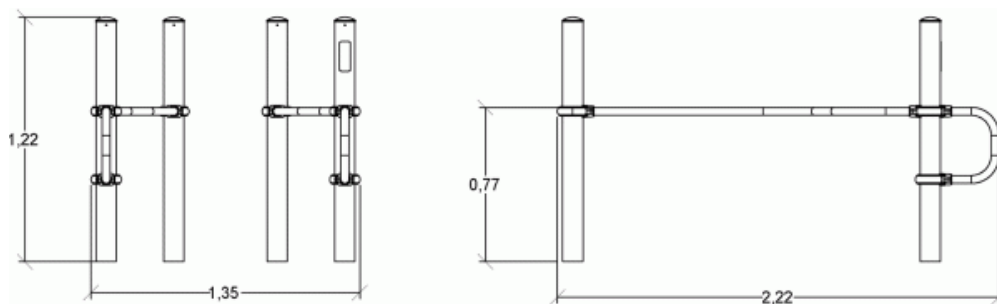

Sports activities : 3

Pull-ups



x1

Dips



x1

Push-ups



x1

muscle strengthening



heart health

balance



coordination

► Installation of equipment

IMPORTANT: It is essential to refer to the installation instructions for information on the size of the safety areas.

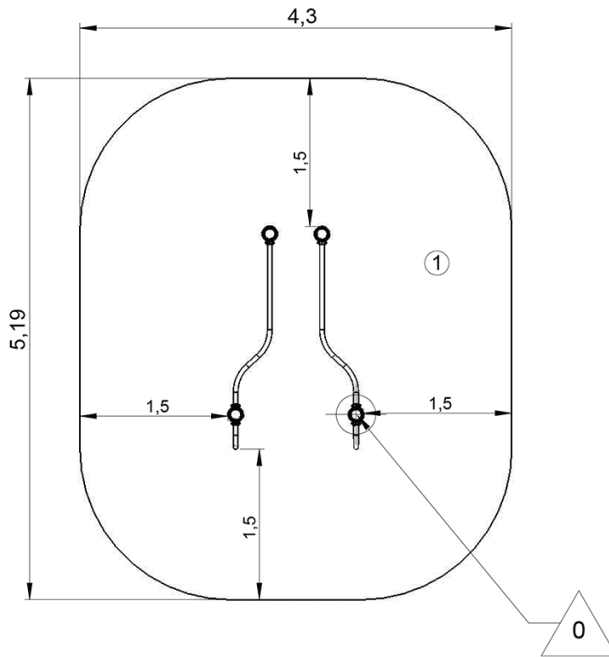
-  Impact area (minimum normative surface)
-  Free space



		
1	0,78m	20,5m ²



2



03h00



0.52m³



20.5m²



79kg



14kg

