

5 11 558 150 81

ecorino Federpodest Punkt







made in germany

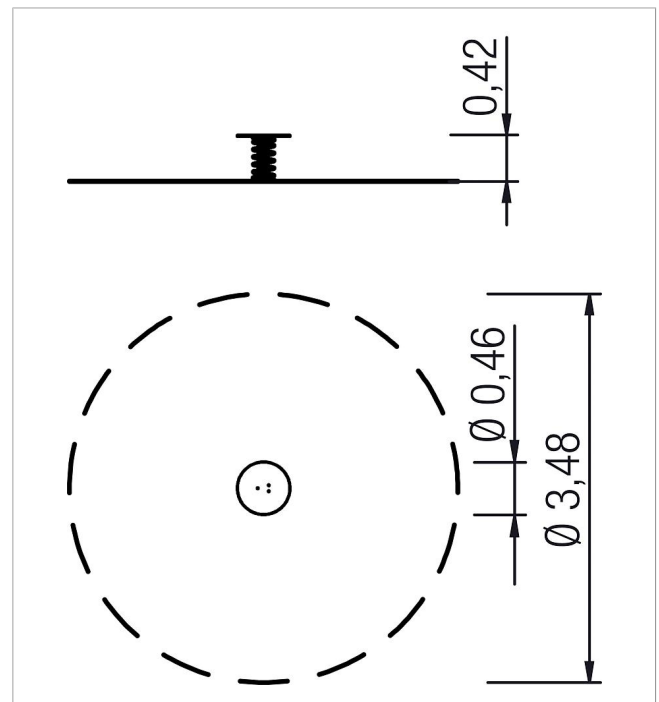

Scope of delivery

1x Federplattform: Hochdrucklaminat (HPL) geriffelt
1x Feder: Federstahl



	Material	NH kdi
	Foundation level	ET 0
	Minimum space	3,48x3,48x2,22 m
	Free falling height	42 cm
	Impact protection net	9,5 m ²
	Foundations	1x 5632280 oder 1x 5632290