

# METEORITE

## with tube



### PRODUCT COMPOSITION

SBR+EPDM rubber granules, aliphatic PU binder, vandal-resistant fiberglass shell, stainless steel (opt. PVC) tube

### COLOR COMBINATION

standard: brown, beige, ocher (other combination on request)

### COLOR STABILITY

UV stable

Product is offered either with PVC or stainless steel tube Ø460mm.

### RECOMMENDED SAFETY SURFACE

safety rubber surface  
(no safety area required according to EN1177)

### PRODUCT SAFETY

certified according to EN1176  
complies with ASTM F1487 and CAN/CSA Z614

### INSTALLATION

the product is installed onto a concrete foundation

### PACKAGING





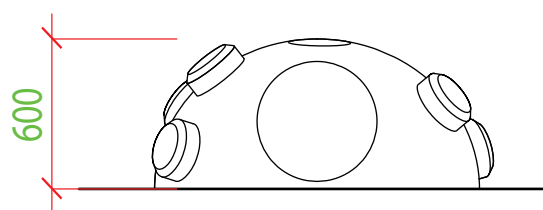
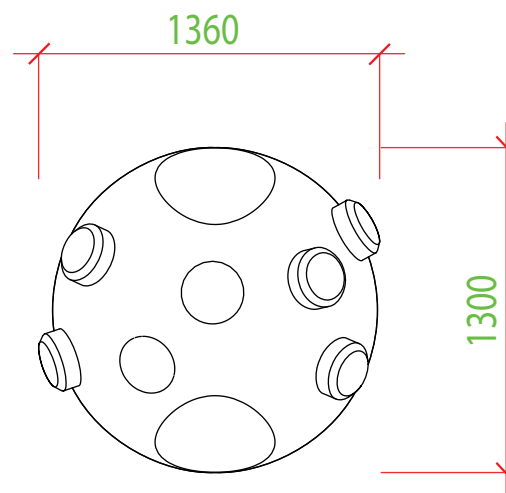

wrapped in plastic and delivered on a pallet 1650 x 2100mm

### STORAGE

in original packaging on a pallet  
in temperatures between - 40° C and 50° C



Our products are handmade, please allow dimensional tolerance up to 40 mm

 <b>120 kg</b> weight	 <b>600 mm</b> critical fall height	 <b>1 h</b> assembly time	 <b>2 - 10 yrs</b> users' age	 <b>3</b> max. number of users	 <b>1300 x 1360</b> <b>h = 600 mm</b>
--	---	---	---	--	---

### 3D PROGRAM, s.r.o.

Objízdná 1911  
765 02 Otrokovice  
Czech Republic



MADE IN EU

www.3dprogram.eu  
info@3dprogram.eu  
+420 602 500 045 +420 577 700 718

