

5 25 149 011 00

unique play unit
Lythea, solo







made in germany

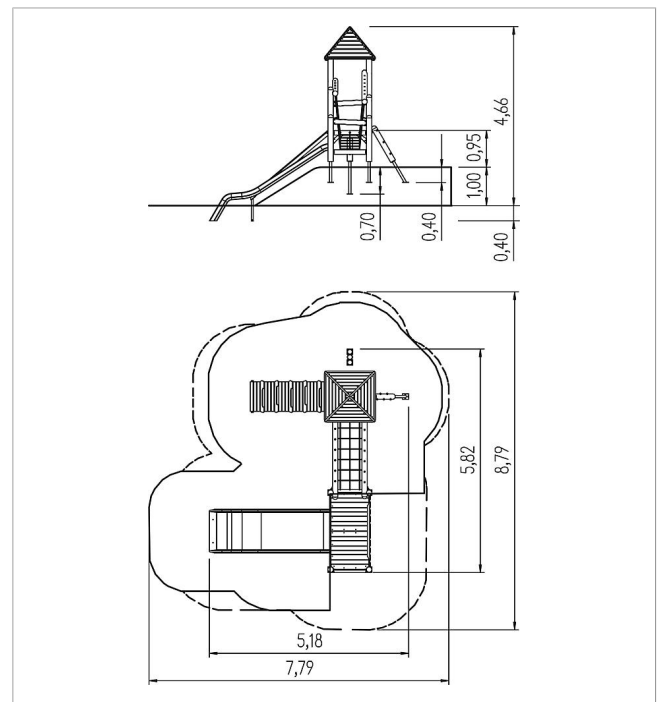

Scope of delivery

8x post unit: softwood or steel
 3x platform: softwood
 2x platform construction: galvanised steel
 1x roof: softwood
 1x buds ascent: softwood
 1x palisade ascent: softwood
 1x ramp: softwood
 1x net bridge sloped: softwood, plastic-coated steel rope
 1x parapet: softwood
 4x walk-through protection: softwood
 1x slide entry board: high-pressure laminate (HPL)
 3x set of climbing grips: aluminium, coated
 fittings: stainless steel



| | | |
|---|-----------------------|---------------------------|
|  | Material | SW pi |
|  | Foundation level | ET 400 |
|  | Minimum space | 7,72x8,80x4,66 m |
|  | Free falling height | 95 cm |
|  | Impact protection net | 39,0 m ² |
|  | Foundations | 12x CF or 11x PFs + 1x Cf |
|  | Largest section | Ø 14x266 cm |