

5 25 917 011 00







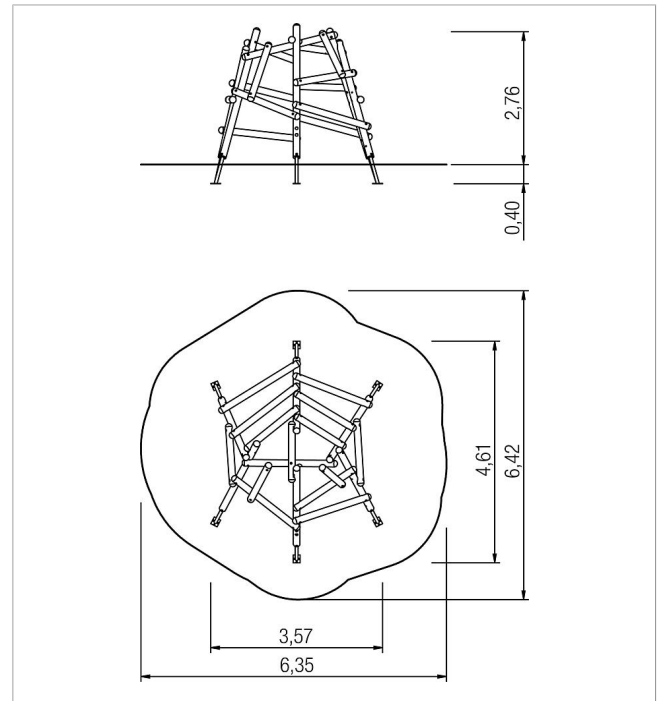

**climbo climbing
structure WirrWarr
Mini**
made in germany



Scope of delivery

6x post construction: softwood
15x beam: softwood
1x net construction: plastic-coated steel cable
fittings: stainless steel (V2A)



	Material	SW pi
	Foundation level	ET 400
	Minimum space	6,35x6,42x2,93 m
	Free falling height	276 cm
	Impact protection net	31,0 m ²
	Foundations	6x CF or 6x PFs
	Assembly	2 persons/4 h
	Largest section	Ø 14x388 cm
	Heaviest section	30 kg