

5 59 838 011 00

## minimondo play unit Coral







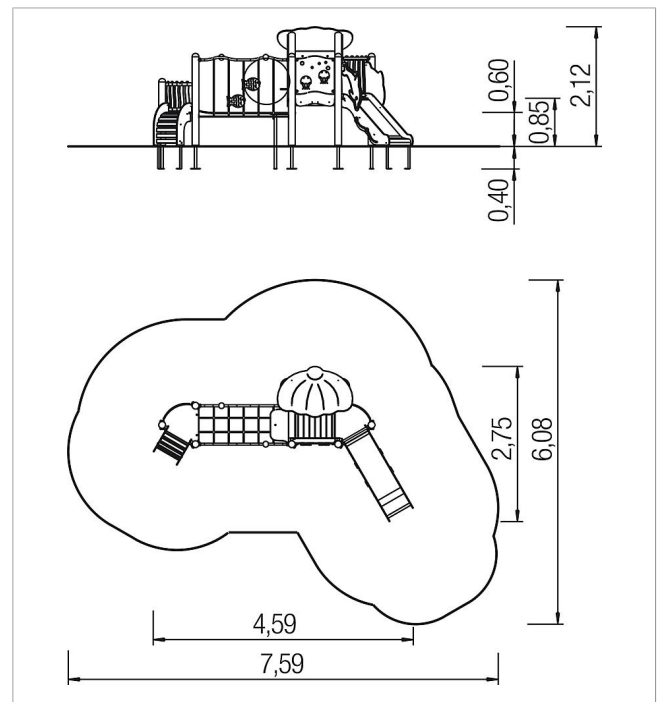

made in germany



### Scope of delivery

- 1x parapet jellyfish: high-pressure laminate (HPL), plastics
- 2x fence element sea grass: stainless steel, high-pressure laminate (HPL)
- 1x slide: high-pressure laminate (HPL), stainless steel
- 1x arched ramp: high-pressure laminate (HPL), softwood
- 1x net bridge: plastic-coated steel cable, stainless steel, high-pressure laminate (HPL)
- 1x roof: high-pressure laminate (HPL)
- 1x wall element with window and shutters: high-pressure laminate (HPL), stainless steel
- 1x bench: high-pressure laminate (HPL)
- 2x platform: high-pressure laminate (HPL), softwood
- 1x wood bottom: high-pressure laminate (HPL), softwood
- 10x post construction: softwood
- 1x set of grips: high-pressure laminate (HPL), plastics
- fittings: stainless steel



	Material	SW pi
	Foundation level	ET 400
	Minimum space	7,55x5,46x2,65 m
	Free falling height	85 cm
	Impact protection net	19,5 m <sup>2</sup>
	Foundations	4x CF or 5x PFs + 6x PFr
	Assembly	2 persons/7 h
	Largest section	215x50x70 cm
	Heaviest section	80 kg