

5 59 859 011 00

minimondo play unit Balloon ride







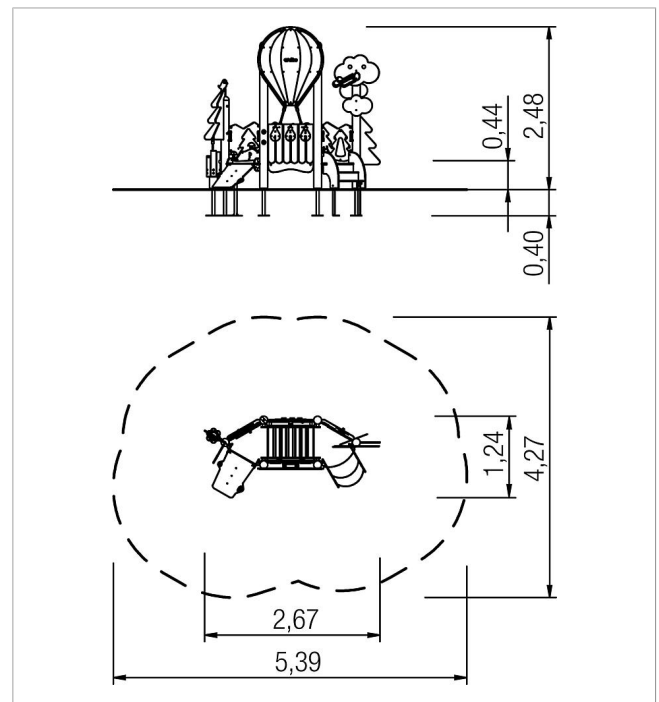

made in germany



Scope of delivery

- 6x post construction: softwood, galvanised steel
- 2x platform construction: high-pressure-laminate (HPL)
- 1x arched bridge: softwood, high-pressure-laminate (HPL)
- 1x belly board: high-pressure-laminate (HPL)
- 1x staircase: high-pressure-laminate (HPL)
- 1x parapet balloon: softwood, high-pressure-laminate (HPL)
- 1x balloon: softwood, high-pressure-laminate (HPL)
- 2x balloon rope: plastic-coated steel cable, plastic
- 3x play parapet: softwood, high-pressure-laminate (HPL), plastic-coated steel cable, plastic, galvanised steel
- 1x stirring drum: softwood, galvanised steel
- 1x fir single: high-pressure-laminate (HPL)
- 2x fir double: high-pressure-laminate (HPL), plastic-coated steel cable, acrylic glass
- 1x cloud large: high-pressure-laminate (HPL)
- 2x cloud small: high-pressure-laminate (HPL)
- 1x telescope: powder-coated steel
- 2x grip set: high-pressure-laminate (HPL), plastic



	Material	SW pi
	Foundation level	ET 400
	Minimum space	5,39x4,27x2,48 m
	Free falling height	44 cm
	Impact protection net	-
	Foundations	8x CF or 3x PFs + 5x PFr
	Largest section	Ø 12x259 cm
	Heaviest section	30 kg